



12-100-01  
No. 1  
For Upper laterals & Canines



12-100-02  
No. 2  
For Upper laterals & Canines



12-100-03  
No. 3  
For upper incisors & canines



21-100-04  
No. 4  
For lower incisors & canines



12-100-05  
No. 7  
For upper premolars

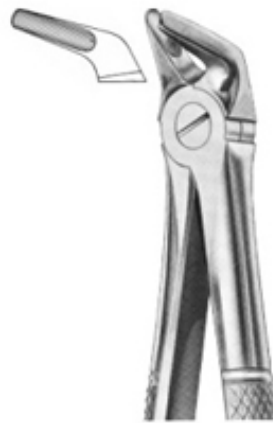

12-100-06  
No. 8  
For upper premolars



12-100-07  
No. 13  
For lower premolars

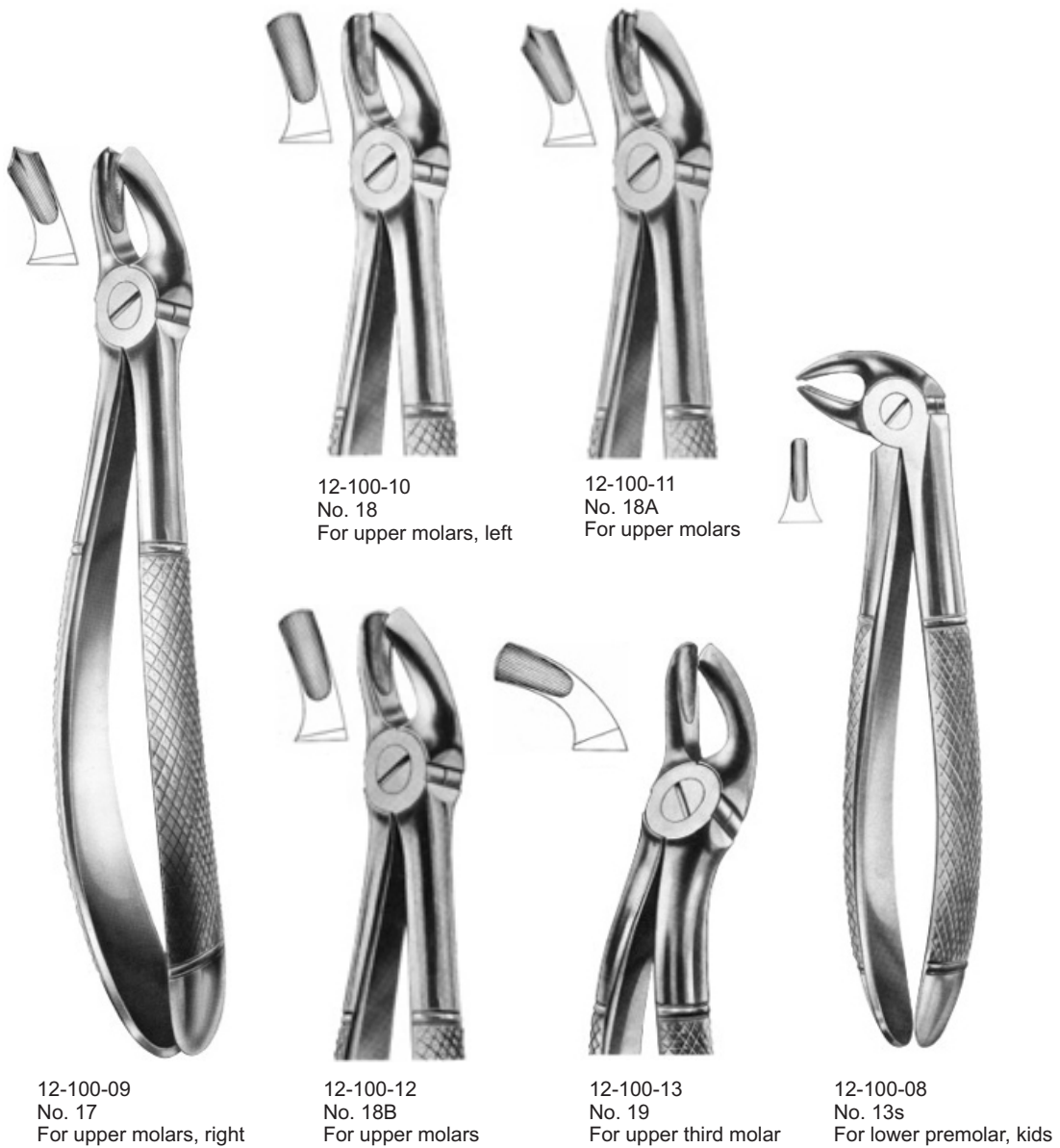

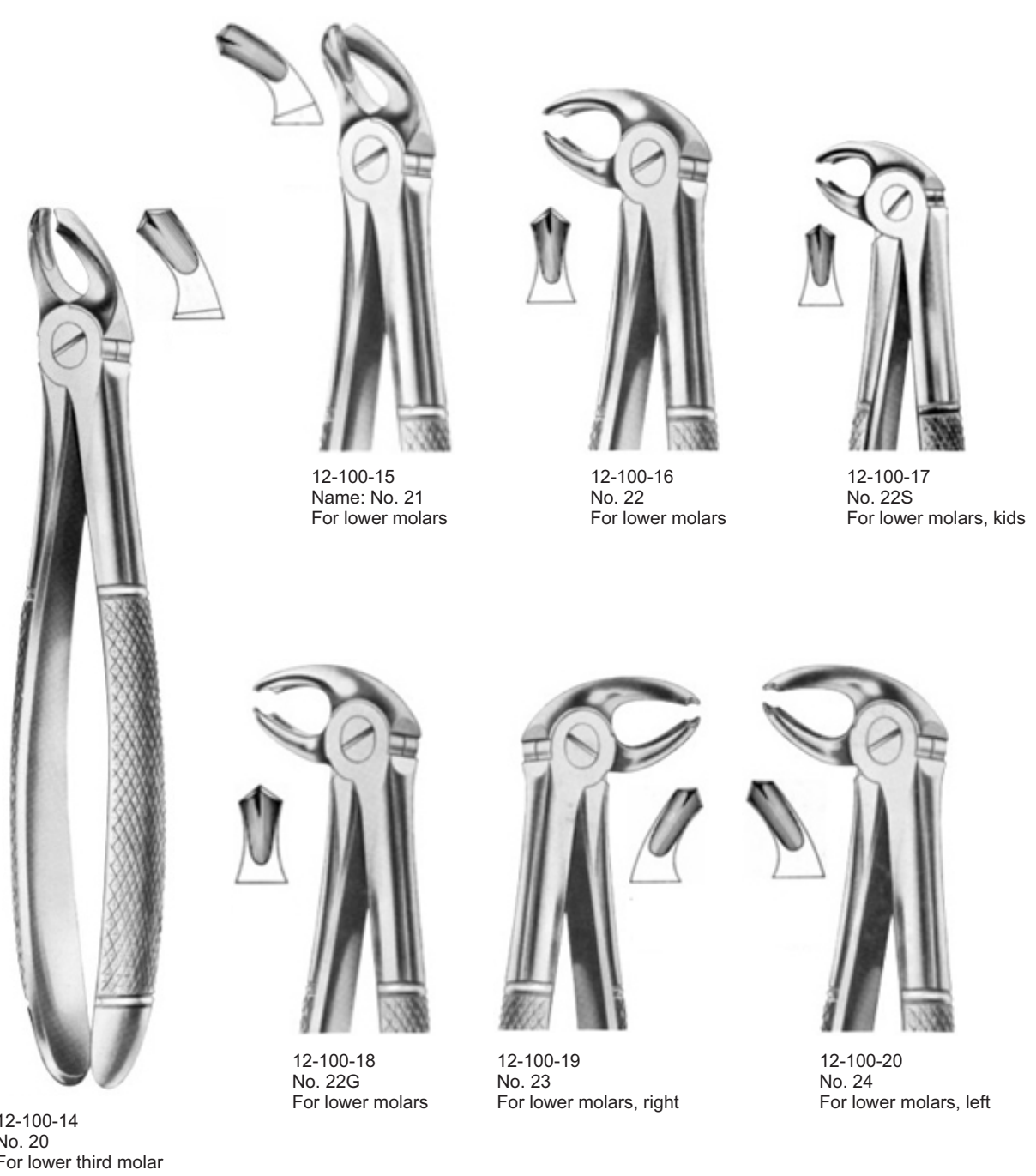

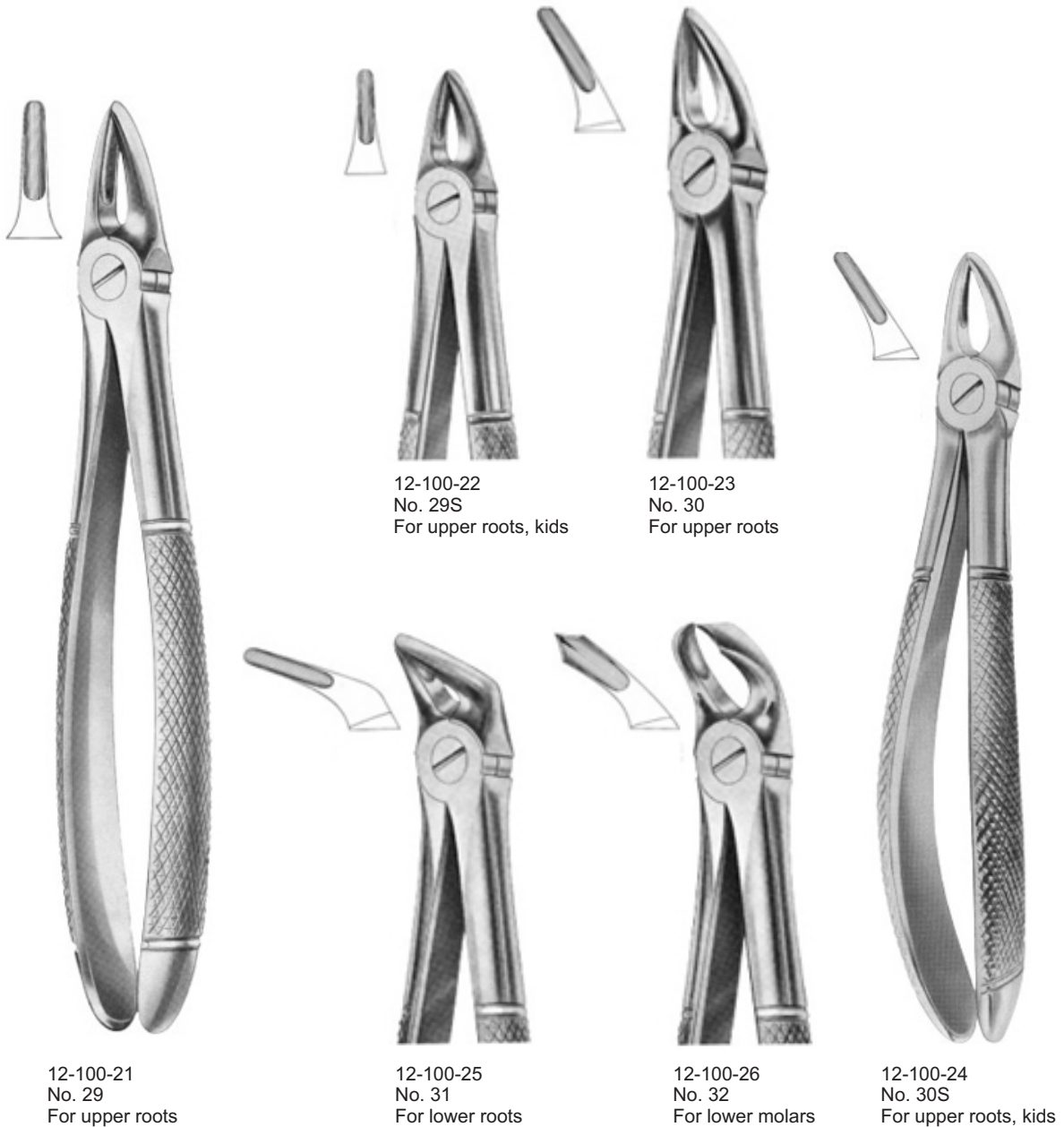

12-100-21  
No. 29  
For upper roots

12-100-22  
No. 29S  
For upper roots, kids

12-100-23  
No. 30  
For upper roots

12-100-25  
No. 31  
For lower roots

12-100-26  
No. 32  
For lower molars

12-100-24  
No. 30S  
For upper roots, kids





# HYGEIA SURGICO



12-100-27  
No. 33  
For lower roots



12-100-28  
No. 33A  
For lower roots



12-100-29  
No. 33C  
For lower roots



12-100-30  
No. 33M  
For lower roots



12-100-32  
No. 37  
For upper incisors, kids



12-100-31  
No. 33S  
For lower roots



12-100-33  
No. 38  
For lower incisors & canines, kids



12-100-34  
No. 39  
For upper molars, kids



12-100-36  
No. 39R  
For upper molars right, kids



12-100-37  
No. 39L  
For upper molars left, kids



12-100-35  
No. 39A  
For upper molars, kids



12-100-38  
No. 40  
For lower molars, kids



# HYGEIA SURGICO

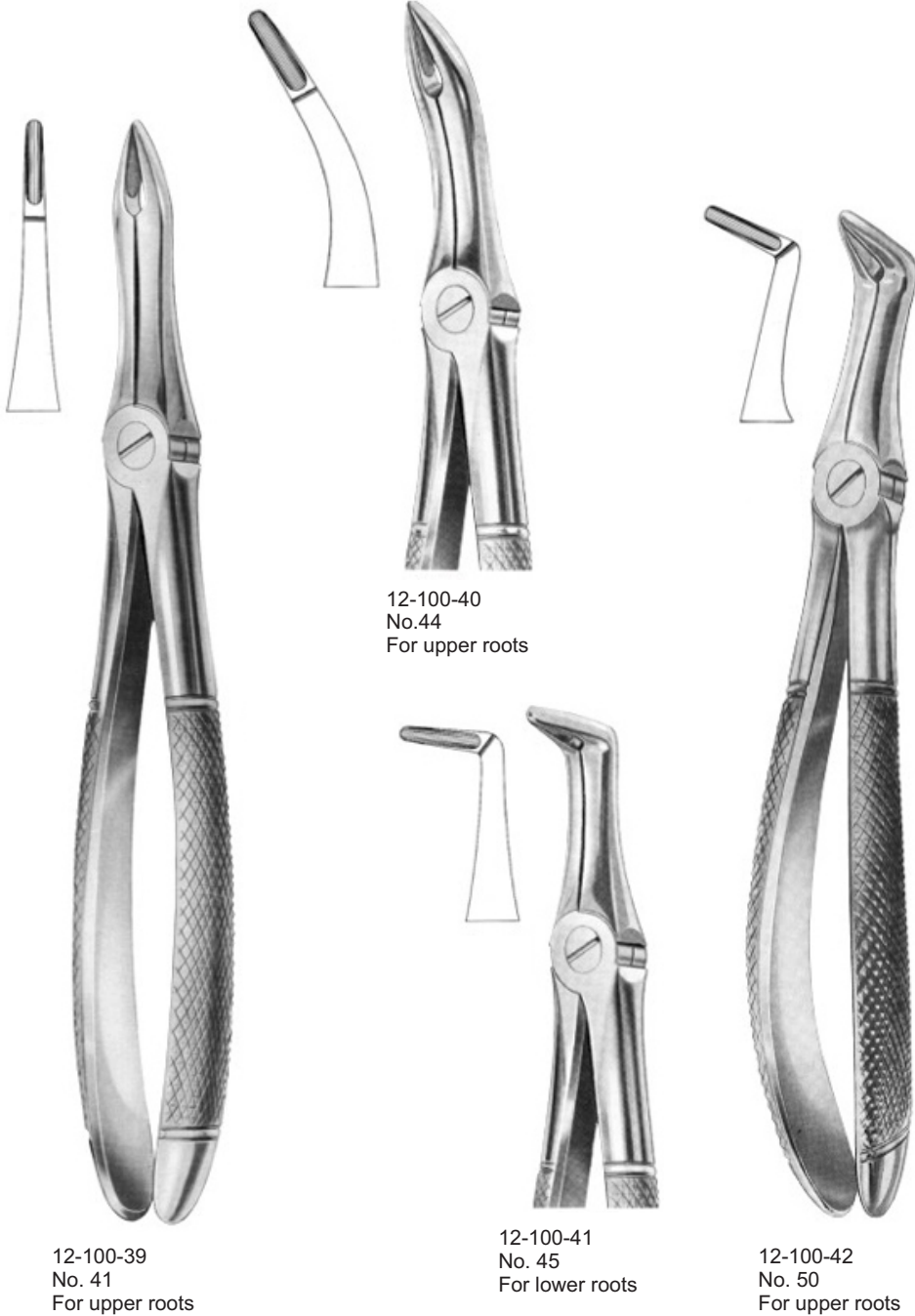



# HYGEIA SURGICO



No. 12-100-43  
No. 51  
For upper roots



12-100-44  
No. 51A  
For upper roots

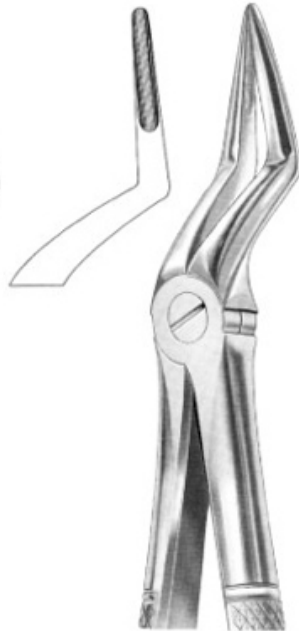

12-100-45  
No. 51L  
For upper roots



12-100-46  
No. 51S  
For upper roots, kids



12-100-47  
No. 52  
For upper roots



12-100-48  
zNo. 52A  
For upper teeth & resection

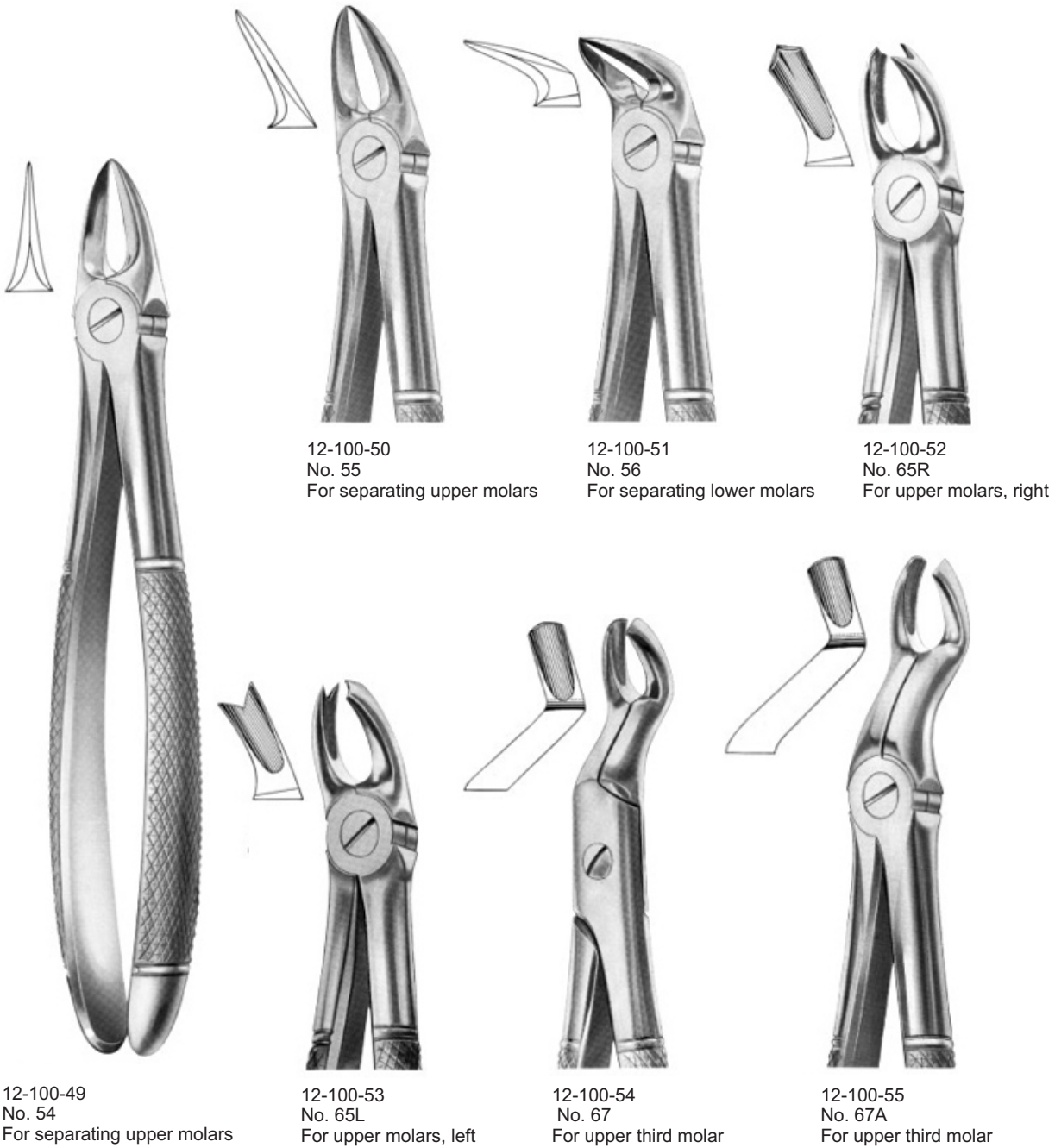

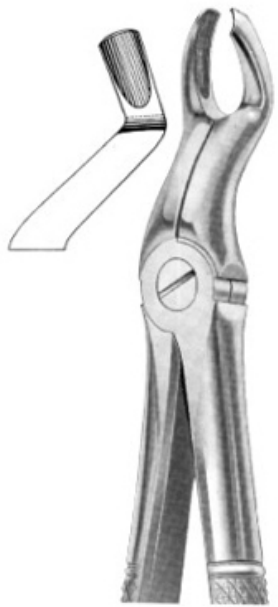

12-100-57  
No. 67 L  
For upper third molar, left



12-100-58  
No. 68  
For lower roots



12-100-59  
No. 68A  
For lower roots



12-100-56  
No. 67R  
For upper third molar, right



12-100-60  
No. 73  
For lower roots



12-100-61  
No. 73 R  
For lower molars, right



12-100-62  
Name: No. 73 L  
For lower molars, left





12-100-63  
No. 73 A  
For lower molars



12-100-65  
No. 73 S  
For lower molars



12-100-64  
No. 73 B  
For lower molars, kids



12-100-66  
No. 73K  
For lower molars, kids



12-100-67  
No. 74  
For lower roots



12-100-68  
No. 74D  
For lower roots





12-100-69  
No. 74M  
For lower roots



12-100-70  
No. 74N  
For lower roots



12-100-71  
No. 74XN  
For lower roots & crowed incisors



12-100-74  
No. 76N  
For upper roots

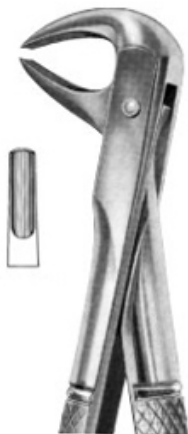

12-100-72  
No. 75  
For lower premolars



12-100-73  
No. 76  
For upper roots



12-100-75  
No. 76S  
For upper roots



12-100-76  
No. 79  
For lower third molar



12-100-77  
No. 79A  
For lower third molar



12-100-79  
No. 81  
For lower premolars & roots

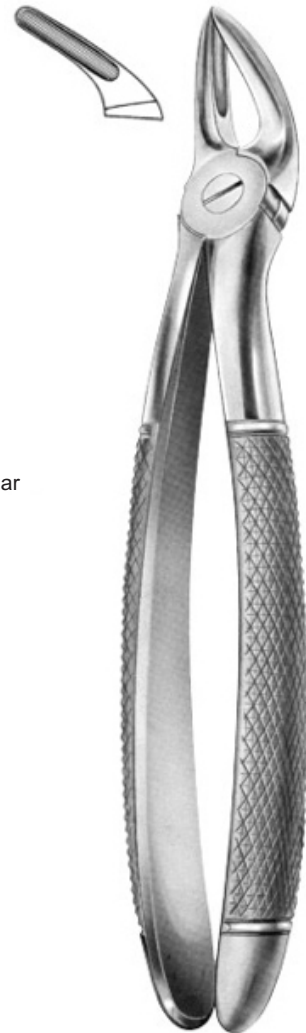

12-100-78  
No. 80  
For upper molars & roots



# HYGEIA SURGICO



12-100-80  
No. 86A  
For lower molars



12-100-81  
No. 86B  
For lower molars



12-100-84  
No. 89  
For upper molars, right



12-100-82  
No. 86C  
For lower molars



12-100-83  
No. 87  
For lower molars



12-100-85  
No. 90  
For upper molars, left



12-100-87  
No. 92  
For upper second molar, right



12-100-88  
No. 93  
For upper molars, left

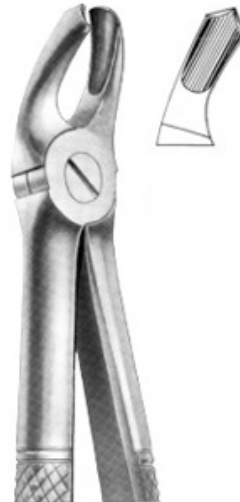

12-100-89  
No. 94  
For upper molars, right



12-100-90  
No. 95  
For upper molars, left



12-100-86  
No. 91  
For separating lower molars



12-100-91  
No. 99 1/2  
For lower molars



12-100-92  
No. 99 1/4  
For lower molars

12-100-93  
No. 101  
For lower molars

12-100-94  
No. 102  
For upper molars, rig

12-100-95  
No. 103  
For upper molars, left

12-100-97  
No. 137  
For lower incisors & roots

12-100-96  
No. 136  
For upper premolars & roots



12-100-98  
No. MD1 (Mead)  
Upper interiors and roots

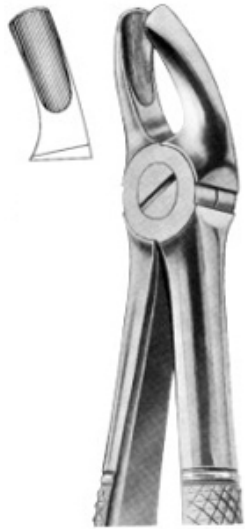

12-100-99  
No. MD2 (Mead)  
For upper molars



12-100-101  
No. Md4 (Mead)  
For lower molars



12-100-100  
No. MD3 (Mead)  
For lower roots



12-100-102  
No. 22 1/2 R  
For lower molars & wisdom, right





12-100-103  
No. 22 ½ L  
For lower molars & wisdom, left



12-100-104  
No. 33 ½ R  
For lower molars & wisdom, right



12-100-105  
No. 33 ½ L  
For lower molars & wisdom, left



*For Kids With Spring*



12-100-107  
No. 5  
For lower incisors



12-100-108  
No. 6  
For lower molars



12-100-109  
No. 7  
For lower roots

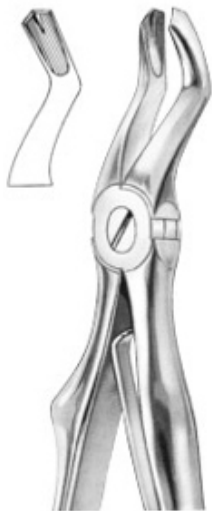

12-100-106  
No. 3  
For upper molars



12-100-110  
No. 137  
For upper incisors



12-100-111  
No. 139  
For upper premolars



12-100-112  
No. 51S  
For upper roots



# HYGEIA SURGICO



12-101-01  
No. W1 (Winter)  
For upper centrals & canines



12-101-02  
No. 1  
For upper incisors & roots



12-101-03  
No. 2  
For upper & lower roots



12-101-04  
No. 4  
For upper & lower premolars

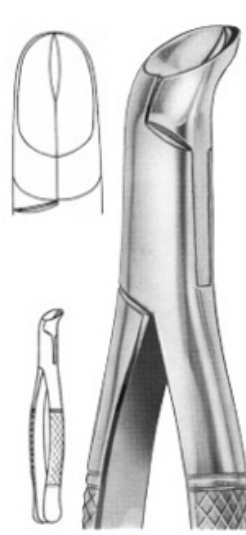

12-101-05  
No. 5  
For lower third molar



12-101-06  
No. 6  
Separating forceps

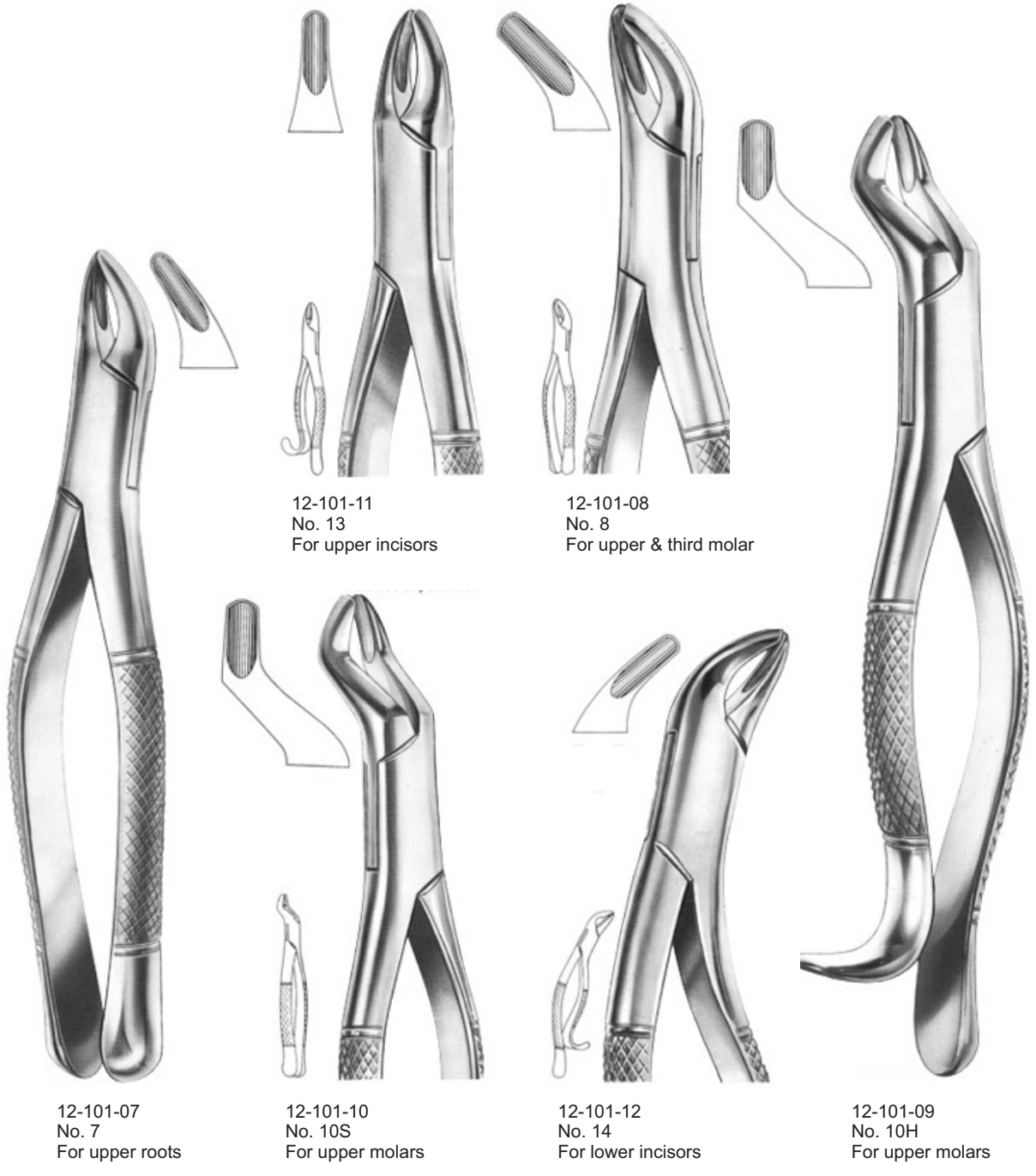

12-101-11  
No. 13  
For upper incisors

12-101-08  
No. 8  
For upper & third molar

12-101-07  
No. 7  
For upper roots

12-101-10  
No. 10S  
For upper molars

12-101-12  
No. 14  
For lower incisors

12-101-09  
No. 10H  
For upper molars

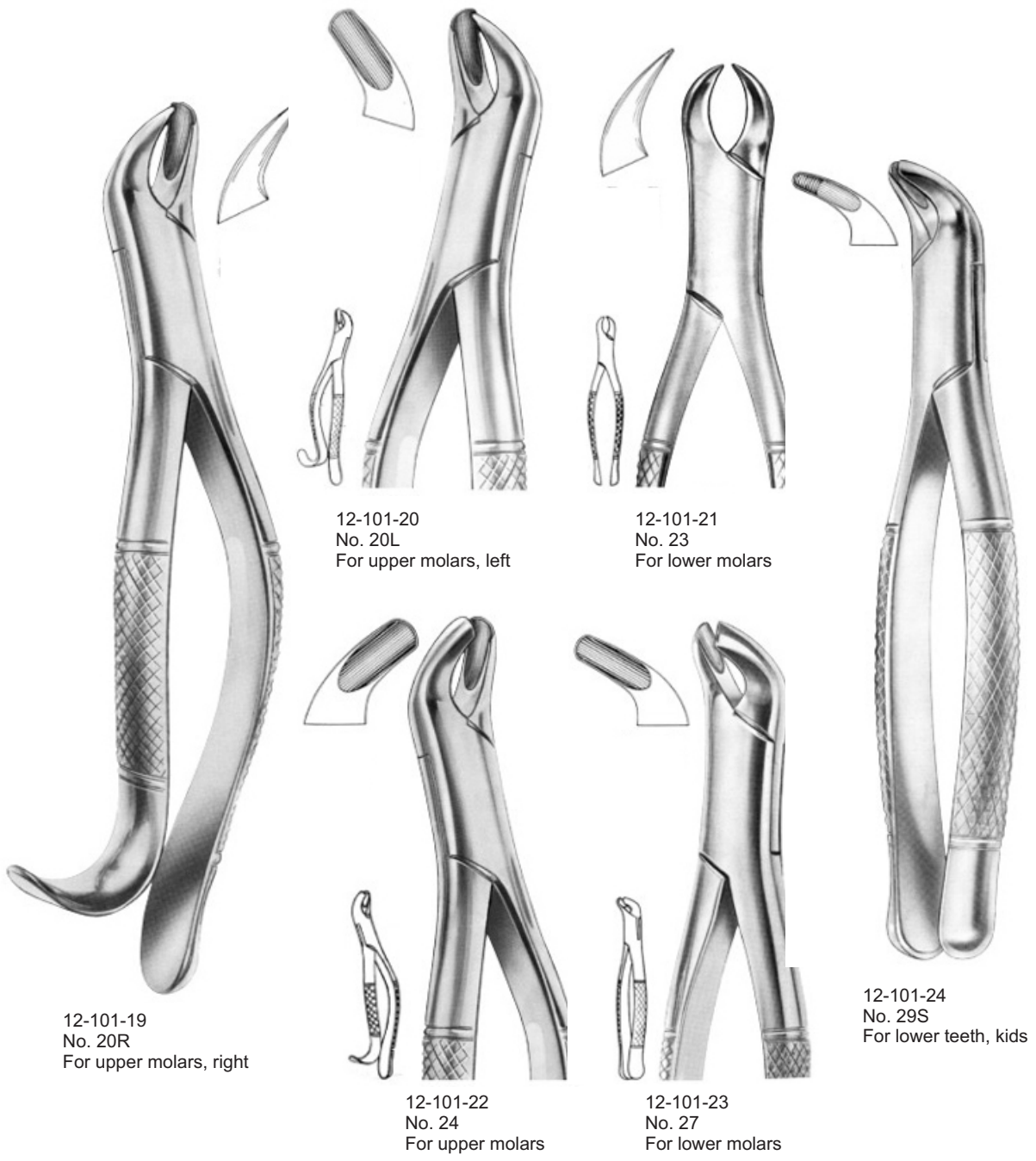



12-101-14  
No. 16  
For lower molars

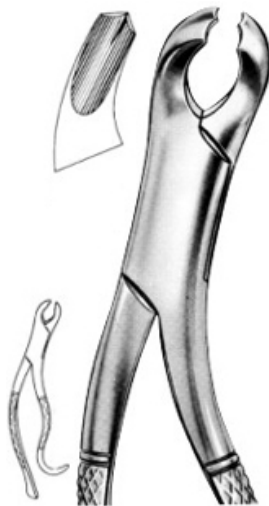

12-101-13  
No. 15 Harris  
For lower molars



12-101-17  
18R Harris  
For upper molars, right



12-101-18  
No. 18L Harris  
For upper molars, left



12-101-15  
No. 16S  
For lower molars, kids

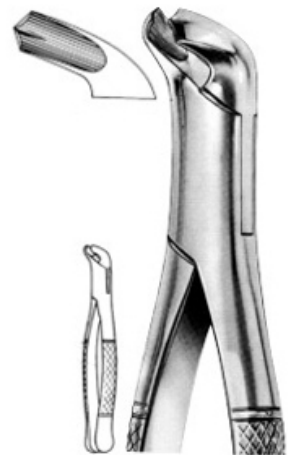

12-101-16  
No. 17  
For lower molars



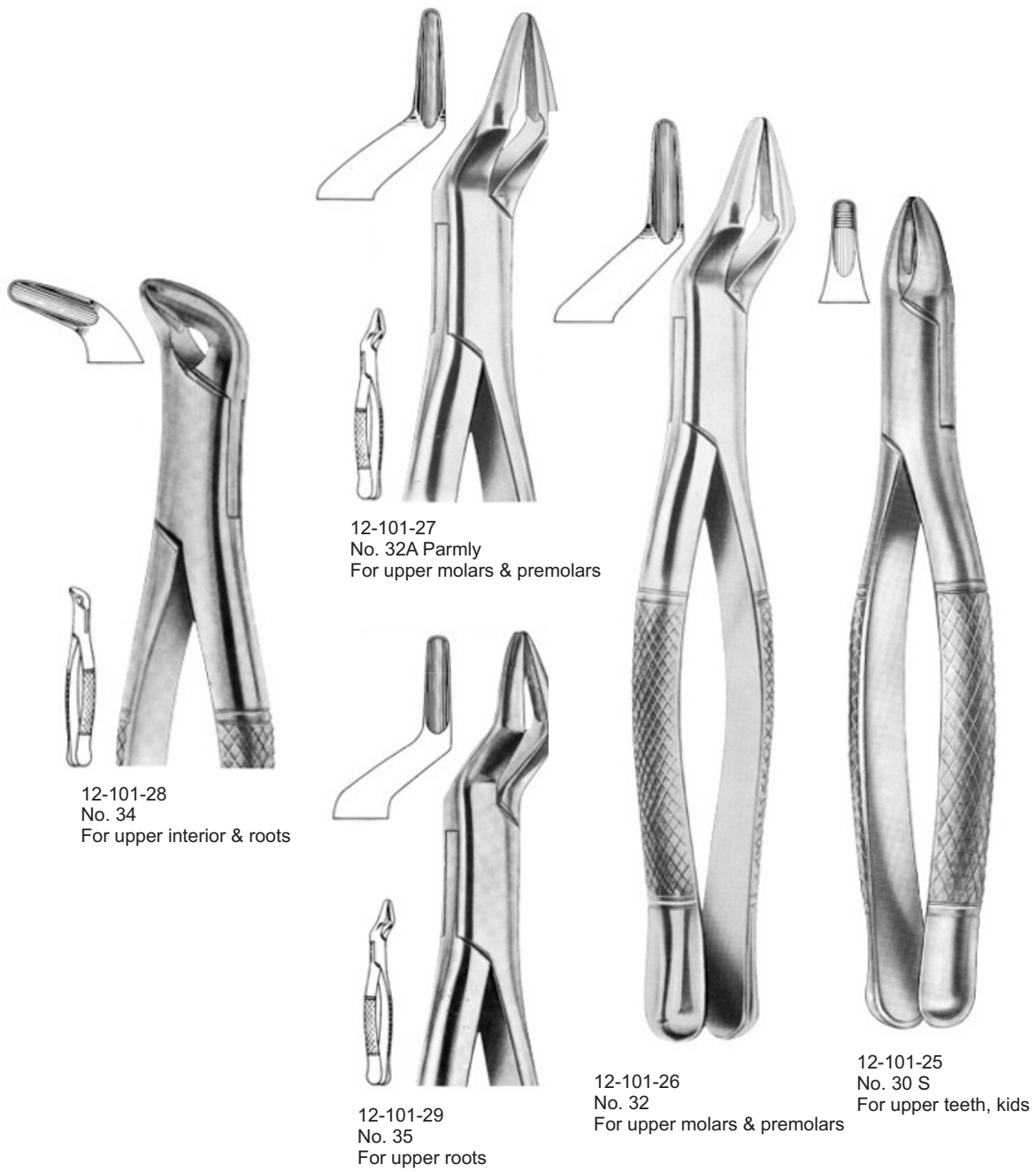

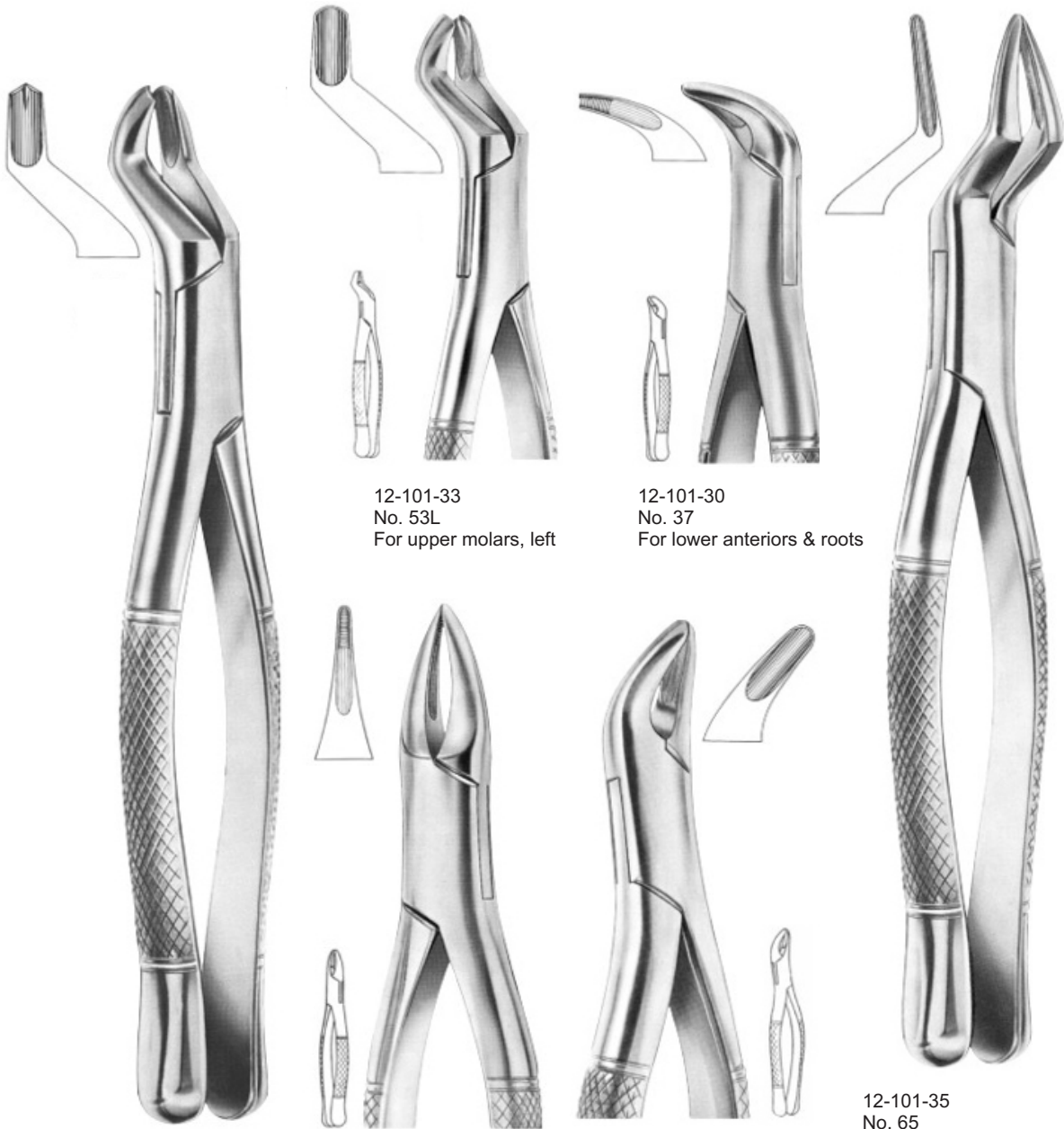

12-101-33  
No. 53L  
For upper molars, left

12-101-30  
No. 37  
For lower anteriors & roots

12-101-32  
No. 53R  
For upper molars, right

12-101-31  
No. 38  
For upper anteriors & roots

12-101-34  
No. 62  
For incisors, premolars & deciduous teeth

12-101-35  
No. 65  
For upper incisors & roots



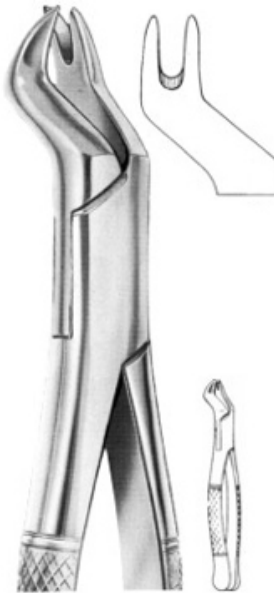

12-101-39  
No. 88R Nevius  
For upper molars, right



12-101-40  
No. 88L Nevius  
For upper molars, left



12-101-36  
No. 69 Tomes  
For upper & lower roots



12-101-37  
No. 85 Thomas  
For lower canines, premolars & molars



12-101-38  
No. 85A Thomas  
For lower canines, premolars & molars



12-101-43  
No. 99A kells  
For upper incisors, canines & premolars

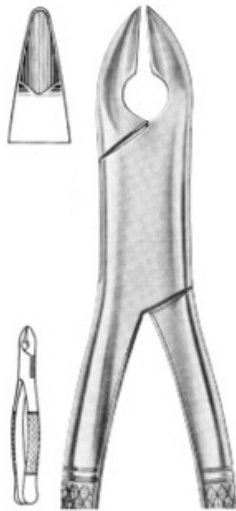

12-101-44  
No. 99C kells  
For upper incisors, canines & premolars



12-101-45  
No. 101 Hull  
For deciduous teeth



12-101-46  
No. 103  
For lower incisors & premolars



12-101-47  
No. 104  
For upper third molar



12-101-49  
No. 150A Cryer  
For upper incisor, premolars & roots

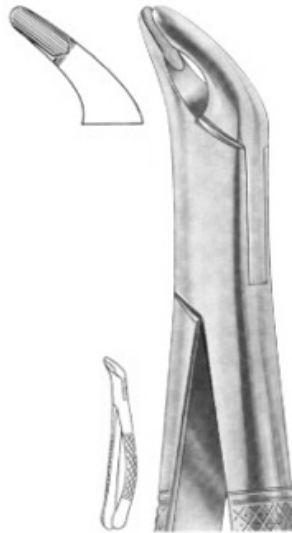

12-101-52  
No. 151A Cryer  
For lower incisors, premolars & roots

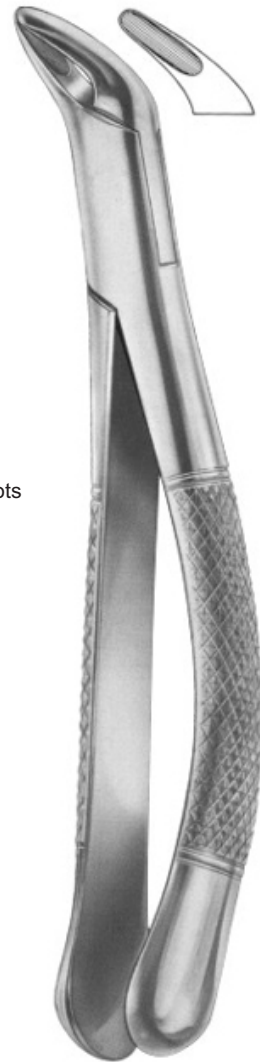

12-101-53  
No. 151S Cryer  
For lower teeth, kids

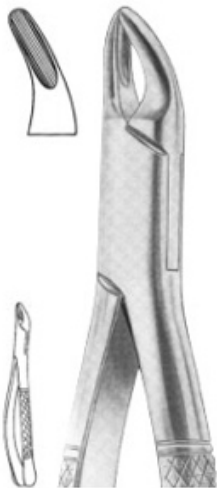

12-101-50  
No. 150S Cryer  
For upper teeth, kids



12-101-48  
No. 150 Cryer  
For upper incisor, premolars & roots

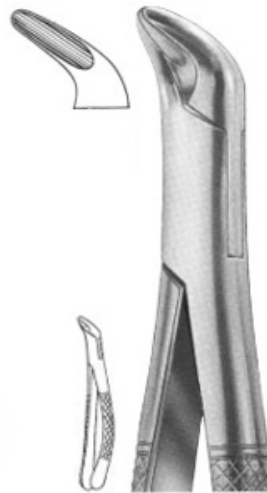

12-101-51  
No. 151 Cryer  
For lower incisors, premolars & roots

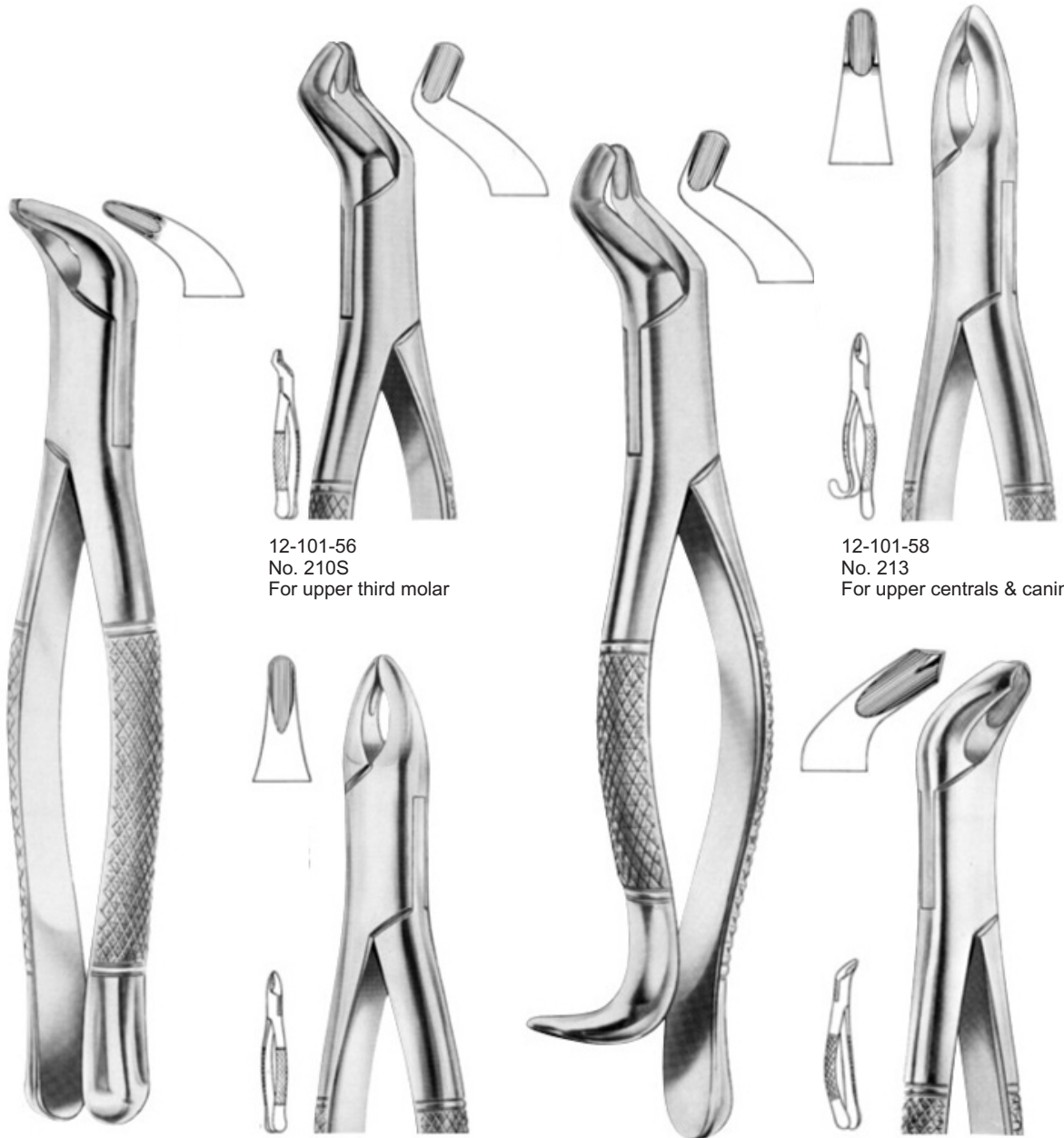

12-101-56  
No. 210S  
For upper third molar

12-101-58  
No. 213  
For upper centrals & canines

12-101-55  
No. 203  
For lower incisors & roots

12-101-54  
No. 201  
For upper incisors,  
canines & premolars

12-101-57  
No. 210H  
For upper third molar

12-101-59  
No. 217  
For lower molars



12-101-62  
No. 287 Swing  
For lower molar

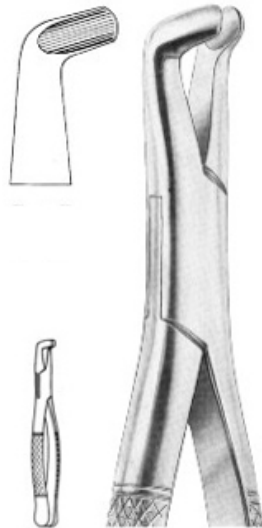

12-101-60  
No. 222  
For lower third molar

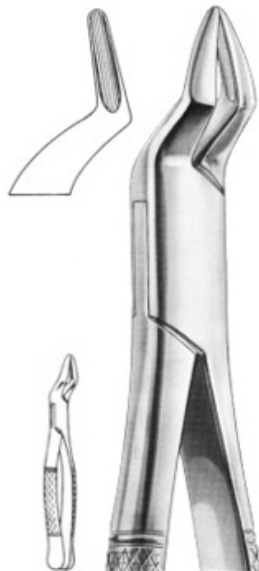

12-101-61  
No. 286  
For upper incisors & roots



12-101-63  
No. 288  
For lower canines & premolars





2-101-64  
No. 3FH Woodward  
For lower molars



12-101-66  
No. 1A Henahan  
For upper incisors



12-101-65  
No. 3FS Woodward  
For lower molars



12-101-67  
Cohen  
Universal Forceps



12-101-69  
No. 23 S  
For lower molars



12-101-68  
No. 17 SK  
For lower molars



12-101-70  
No. 150 SK  
For upper interiors & root



12-101-71  
No. 151 SK  
For lower interior & root





# HYGEIA SURGICO



12-102-01  
Witzel  
For lower roots



12-102-02  
Witzel  
For uppe roots



12-102-03  
Stieglitz  
For root fragments



12-102-04  
Stieglitz  
For root fragments



# HYGEIA SURGICO



12-103-01  
Seldin  
No. 1L



12-103-02  
Seldin  
No. 1R



12-103-03  
Seldin  
No. 4L



12-103-04  
Seldin  
No. 4R



12-103-05  
Seldin  
No. 34S



12-103-06  
Seldin  
No. 34



12-103-07  
Seldin  
No. 2S



12-103-08  
Seldin  
No. 3S



12-103-09  
Seldin  
No. 301W



12-103-10  
Seldin  
No. 304W



12-103-11  
Cryer  
No. 25



12-103-12  
Cryer  
No. 26



12-103-13  
Cryer  
No. 31



12-103-14  
Cryer  
No. 32



12-103-15  
Cryer  
No. 44



12-103-16  
Cryer  
No. 45



# HYGEIA SURGICO



12-103-17  
Flohr  
No. 1F  
Tip 3mm



12-103-18  
Flohr  
No. 2F  
Tip 3.5mm



12-103-19  
Flohr  
No. 3F  
Tip 3.5mm



12-103-20  
Bein  
No. 1  
Tip 2mm



12-103-21  
Bein  
No. 2  
Tip 3mm



12-103-22  
Bein  
No. 3  
Tip 3.7mm



12-103-23  
Bein  
No. 4  
Tip 3mm



12-103-24  
Bein  
No. 5  
Tip 3.7mm



12-103-25  
Bein  
No. 6  
Tip 4.3mm



12-103-26  
Bein  
No.1B  
Tip 3mm



12-103-27  
Bein  
No.2B  
Tip 4mm



12-103-28  
Bein  
No.3B  
Tip 3mm



12-103-29  
Bein  
No.4B  
Tip 4mm



12-103-30  
Bein  
No.5B  
Tip 3.2mm



12-103-31  
Bein  
No.6B  
Tip 3.8mm



# HYGEIA SURGICO



12-103-32  
Stout  
No. 11



12-103-33  
Stout  
No. 11A



12-103-34  
Stout  
No. 12



12-103-35  
Miller  
No. 71



12-103-36  
Miller  
No. 72



12-103-37  
Miller  
No. 73



12-103-38  
Miller  
No. 74



12-103-39  
Schmeckeber  
No. 4SA  
Flat Point



12-103-40  
Schmeckeber  
No. 5SA  
Flat Point



12-103-41  
Schmeckeber  
No. 4B  
Concave Point



12-103-42  
Schmeckeber  
No. 5B  
Concave Point



12-103-43  
Kopp  
No. 1K  
Tip 3.6mm



12-103-44  
Kopp  
No. 2K  
Tip 3.6mm



12-103-45  
Kopp  
No. 3K  
Tip 4.2mm



12-103-46  
Kopp  
No. 4K  
Tip 4.2mm



12-103-47  
Kopp  
No. 5K  
Tip 3.8mm



12-103-48  
Kopp  
No. 6K  
Tip 3.8mm



12-103-49  
Curtis  
No. 51



12-103-50  
Curtis  
No. 52



12-103-51  
Cogswell  
No. A



12-103-52  
Coupland  
No. 1C



12-103-53  
Coupland  
No. 2C



12-103-54  
Coupland  
No. 3C



12-103-55  
Coupland  
No. A1C



12-103-56  
Coupland  
No. A2C



12-103-57  
Coupland  
No. A3C



12-103-58  
Heidbrink  
No. 1H



# HYGEIA SURGICO



12-103-59  
Heidbrink  
No. 2H



12-103-60  
Heidbrink  
No. 40H



12-103-61  
Heidbrink  
No. 41H



12-103-62  
Friedman  
No. 31F



12-103-63  
Friedman  
No. 32F



12-103-64  
Apexo  
No. 301



12-103-65  
Apexo  
No. 302



12-103-66  
Apexo  
No. 303



12-103-67  
Mac Millan  
No. 11M



12-103-68  
Mac Millan  
No. 12M



12-103-69  
Mac Millan  
No. 13M



12-103-70  
No. 190



12-103-71  
No. 191



12-103-72  
Woodward  
No. 15



12-103-73  
Woodward  
No. 16





# HYGEIA SURGICO



12-103-74  
Hylin  
No. 1



12-103-75  
Hylin  
No. 2



12-103-76  
Hylin  
No. 3



12-103-77  
Hylin  
No. 4



12-103-78  
Coleman  
No. 1



12-103-79  
London Hospital  
No. 2



12-103-80  
London Hospital  
No. 3



12-103-81  
No. 1



12-103-82  
No. 2



12-103-83  
Lecluse  
No. 1LC



# HYGEIA SURGICO



12-103-84  
Winter  
No. 1LW



12-103-85  
Winter  
No. 1RW



12-103-86  
Winter  
No. 11LW



12-103-87  
Winter  
No. 11RW



12-103-88  
Winter  
No. 12LW



12-103-89  
Winter  
No. 12RW



12-103-90  
Winter  
No. 14LW



12-103-91  
Winter  
No. 14RW



12-103-92  
Winter F. Barry  
No. 320



12-103-93  
Winter F. Barry  
No. 321



12-103-94  
Winter F. Barry  
No. 322



12-103-95  
Winter F. Barry  
No. 323



12-103-96  
Winter F. Barry  
No. 350



12-103-97  
Winter F. Barry  
No. 351



12-103-98  
Winter F. Barry  
No. 370



12-103-99  
Winter F. Barry  
No. 371



12-103-100  
Pott  
No. 24



12-103-101  
Pott  
No. 25



12-103-102  
Warwick - James  
No. 1



12-103-103  
Warwick - James  
No. 2



12-103-104  
Warwick - James  
No. 3



# HYGEIA SURGICO



12-103-105  
Heidbrink  
No. 1



12-103-106  
Heidbrink  
No. 2

12-103-107  
Heidbrink  
No. 3



12-103-108  
Heidbrink  
No. 1



12-103-109  
Heidbrink  
No. 2

12-103-110  
Heidbrink  
No. 3



12-103-111



12-103-112 No. 0    12-103-113 No. 1    12-103-114 No. 2    12-103-115 No. 3    12-103-116 No. 4    12-103-117 No. 5



12-103-118 No. 6    12-103-119 No. 7    12-103-120 No. 8    12-103-121 No. 9    12-103-122 No. 11    12-103-123 No. 21



12-103-124 No. 22    12-103-125 No. 23    12-103-126 No. 24    12-103-127 No. 25    12-103-128 No. 26    12-103-129 No. 27    12-103-130 No. 28    12-103-131 No. 29



# HYGEIA SURGICO



12-103-132  
Chompret  
No. 1



12-103-133  
Chompret  
No. 2



12-103-134  
Chompret  
No. 3



12-103-135  
Chompret  
No. 4



# db HYGEIA SURGICO

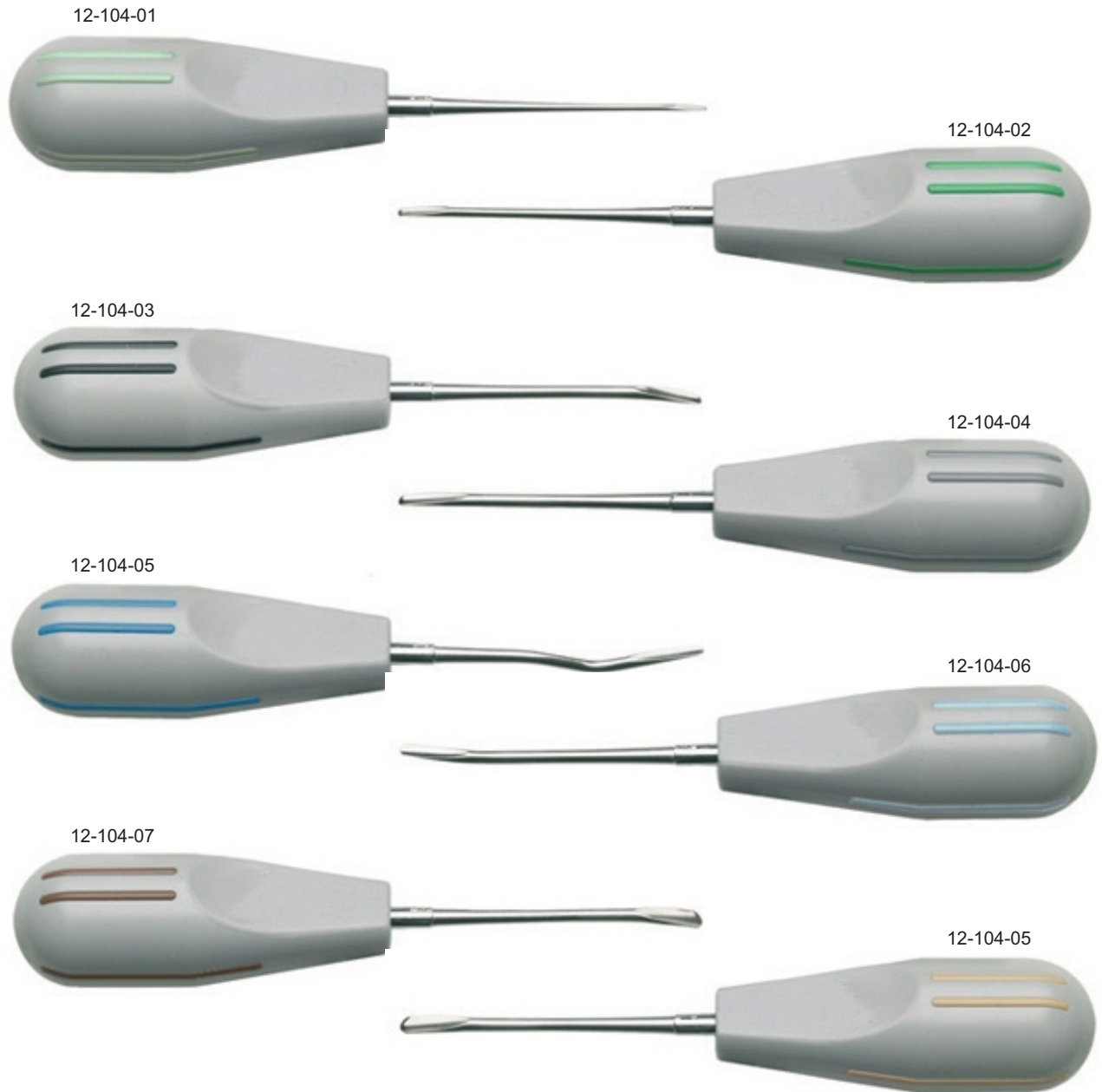

<b><u>Art No.</u></b>	<b><u>Detail</u></b>	<b><u>Colour</u></b>	<b><u>Indication</u></b>	<b><u>Working End</u></b>
12-104-01	Straight Blade 1mm	Light Green	Integrates periostome properties	
12-104-02	Straight Blade 2mm	Green	Apical and / or interproximal	
12-104-03	Curved Blade 3mm	Black	General use / Starter	
12-104-04	Straight Blade 3mm	Grey	Interproximal	
12-104-05	Contra Angle Blade 3mm	Blue	lingual and / or Distal - Molars	
12-104-06	Inverted Curved Blade 3mm	Light Blue	General lingual and / or Distal	
12-104-07	Curved Blade 5mm	Brown	Large Molar Roots / General Use	
12-104-08	Straight Blade 5mm	Tan	Interproximal	



12-105-01  
Blumenthal  
30 Degree  
15cm



12-105-02  
Blumenthal  
45 Degree  
14.5cm



12-105-03  
Blumenthal  
90 Degree  
14cm



12-105-04  
Mead 1A  
16.5cm



12-105-05  
Beyer  
18cm



12-105-06  
Ruskin - Mini  
15.5cm



12-105-07  
Luer  
15cm



12-105-08  
Friedman  
14cm



12-105-09  
Friedman - Mini  
12cm



12-106-01  
Dental Syringe  
Three Rings  
1.8 ml



12-106-02  
Dental Syringe  
1.8 ml



12-106-03  
Dental Syringe  
Folding  
1.8 ml  
2.2 ml

**Standard Tip**

**Available Tips**



CWT



RT



AT



RT



12-106-04  
Dental Syringe  
1.8 ml



12-106-05  
Dental Syringe  
1.8 ml



# HYGEIA SURGICO



12-106-06  
Syringe  
1.8 ml

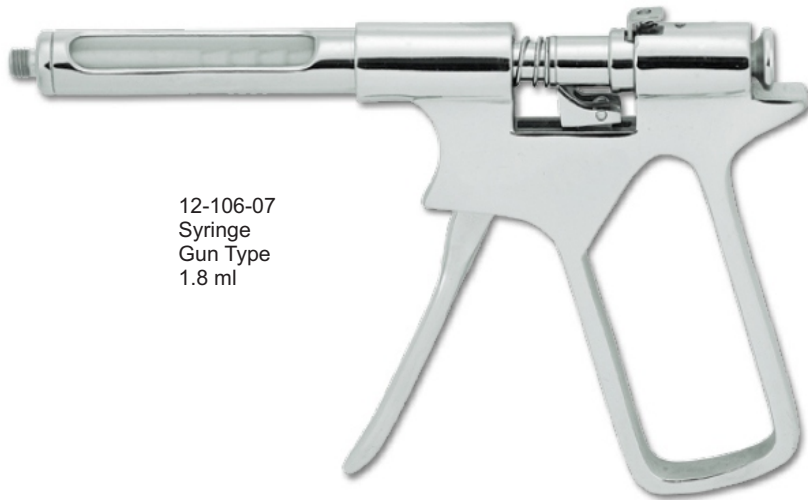

12-106-07  
Syringe  
Gun Type  
1.8 ml



# HYGEIA SURGICO

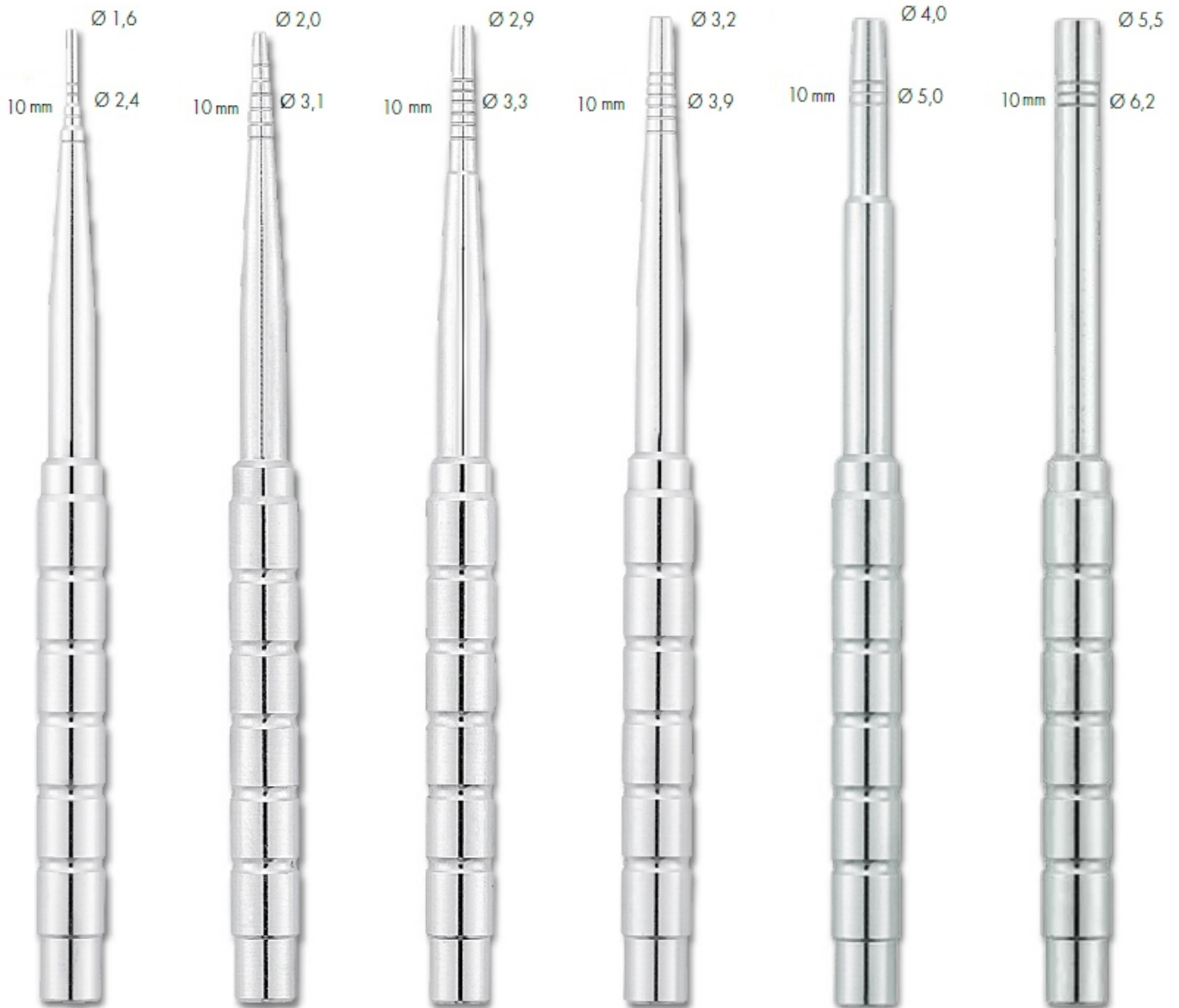

12-107-01

Concave End  
15.5cm

12-107-02

Concave End  
15.5cm

12-107-03

Concave End  
15.5cm

12-107-04

Concave End  
15.5cm

12-107-05

Concave End  
15.5cm

12-107-06

Concave End  
15.5cm

Measuring Chart

No. 4  
22 mm

No.5  
24 mm



Simple Stem

12-108-01  
Mirror No. 4  
Plain

12-108-02  
Mirror No. 5  
Plain



Cone Socket

12-108-03  
Mirror No. 4  
Plain

12-108-04  
Mirror No. 5  
Plain



Simple Stem

12-108-05  
Mirror No. 4  
Magnifying

12-108-06  
Mirror No. 5  
Magnifying



Cone Socket

12-108-07  
Mirror No. 4  
Magnifying

12-108-08  
Mirror No. 5  
Magnifying



12-108-09  
Rhodium Coated  
Front Surface



12-108-10  
Rhodium Coated  
Front Surface

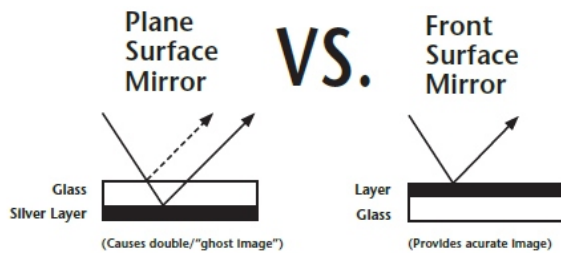

12-108-11  
Double Sided Mouth Mirror  
Rhodium Coated  
Front Surface





**Simple Stem Mirrors**

12-109-01	12-109-02	12-109-03	12-109-04	12-109-05	12-109-06
Round, Solid	Hollow	Octangle, Solid	Round, Solid	Hollow	Hollow

**Cone Socket Mirrors**

12-109-07	12-109-08	12-109-09	12-109-10	12-109-11	12-109-12
Round, Solid	Hollow	Octangle, Solid	Round, Solid	Hollow	Hollow



# HYGEIA SURGICO

12-110-01  
Flag  
Serrated  
15cm



12-110-02  
College  
Serrated  
15cm



12-110-03  
Merriam  
Serrated  
16cm



12-110-04  
Perry  
Serrated  
13cm



12-110-05  
Self Locking  
Serrated  
16cm



12-110-06  
Self Locking  
Serrated  
15cm



12-110-07  
Self Locking  
Serrated, Grooved  
15cm



12-110-08  
Gpldman -Fox  
Pocket Marker  
15cm



12-110-09  
Gpldman -Fox  
Pocket Marker  
15cm





12-111-01  
Fig. 2



12-111-02  
Fig. 3



12-111-03  
Fig. 3A



12-111-04  
Rhein  
Fig. 3R



12-111-05  
Fig. 5



12-111-06  
Fig. 6



12-111-07  
Fig. 8



12-111-08  
Fig. 9



12-111-09  
Fig. 10



12-111-10  
Fig. 11



12-111-11  
Fig. 12



12-111-12  
Fig. 16



12-111-13  
Fig. 17



12-111-14  
Fig. 17A



12-111-15  
Fig. 23



# HYGEIA SURGICO



12-112-01  
Cattoni  
Fig. UT ½



12-112-02  
Fig. 2



12-112-03  
Fig. 2A



12-112-04  
Fig. 3



12-112-05  
Fig. 16/23



12-112-06  
Fig. 16/3



12-112-07  
Fig. 23/17



12-112-08  
Fig. 23/17A

Color Coded



12-113-01  
Fig. 23/CP11



12-113-02  
Fig. 23/CP12



12-113-03  
Goldman - Fox  
Fig. 3  
Flat



12-113-04  
Goldman - Fox  
Fig. 16  
Flat



12-113-05  
Goldman - Fox  
Fig. 17  
Flat



12-113-06  
Goldman - Fox  
Fig. 23  
Flat



12-113-09  
University of Michigan  
Fig. 17



12-113-10  
University of Michigan  
Fig. 23



12-111-12  
Williams  
Fig. 16



12-111-13  
Williams  
Fig. 17



12-113-14  
Williams  
Fig. 23



# HYGEIA SURGICO



12-114-01  
Goldman - Fox  
Williams



12-114-02  
Nabers  
Fig. 1N



12-114-03  
Nabers  
Fig. 2N



12-114-04  
Nabers  
Fig. 2N

### Color Coded



12-114-05  
CP-C



12-114-06  
CP-11



12-114-07  
CP-12



12-114-08  
CP-12S



12-114-09  
Williams



12-114-10  
Merrit A



12-114-11  
Merrit B



12-114-12  
Goldman Fox  
Flat



12-114-13  
Uni of michigan



12-114-14  
26 G



**Spreader**

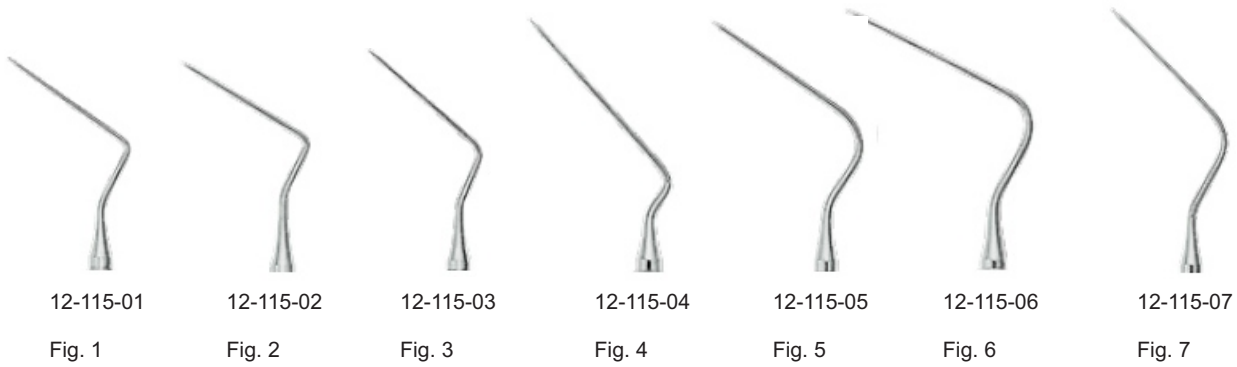

**Root Canal Pluggers**

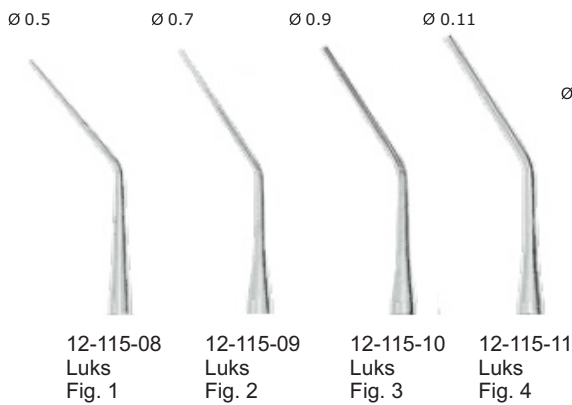

**Vertical Condenser**

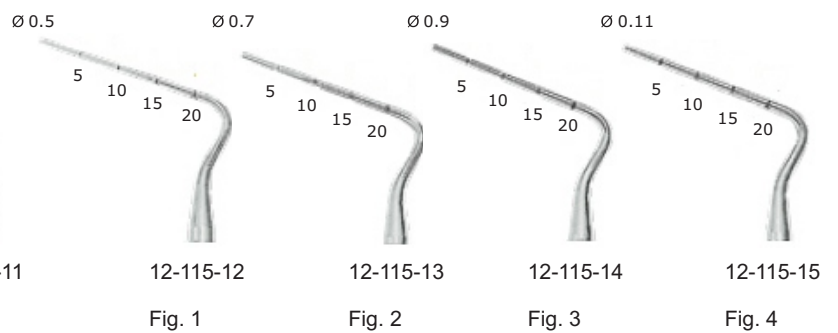



# HYGEIA SURGICO

***For upper & lower anterior***



12-116-01  
No. 6



12-116-02  
No. 9

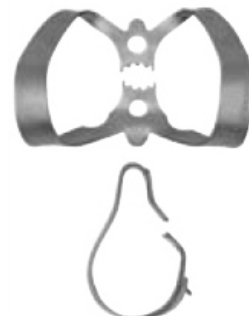

12-116-03  
No. 9S



12-116-04  
No. 212



12-116-05  
No. 212SA



12-116-06  
No. 00

***For upper & lower premolars***



12-116-07  
No. 0



12-116-08  
No. 1



12-116-09  
No. 1A



12-116-10  
No. 2



# HYGEIA SURGICO

## For upper & lower premolars

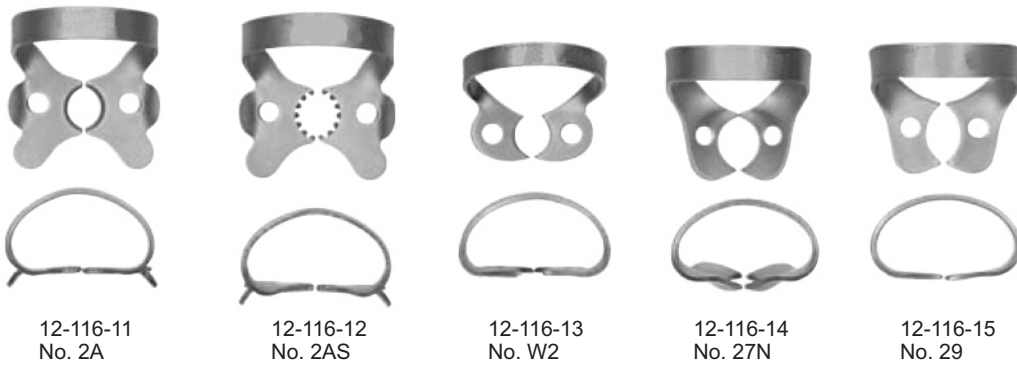

## For upper molars

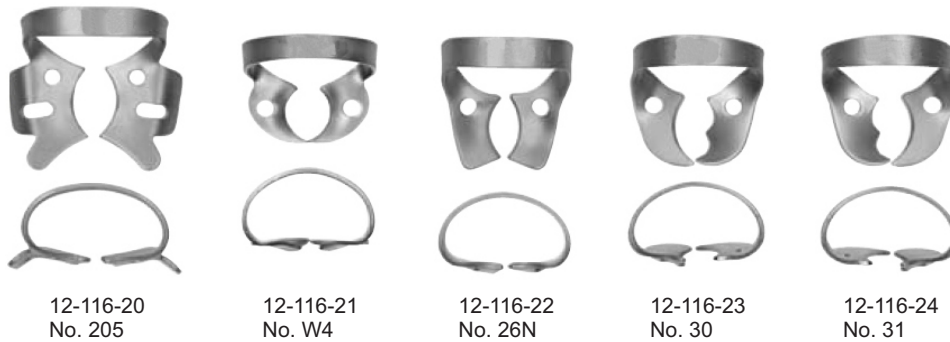
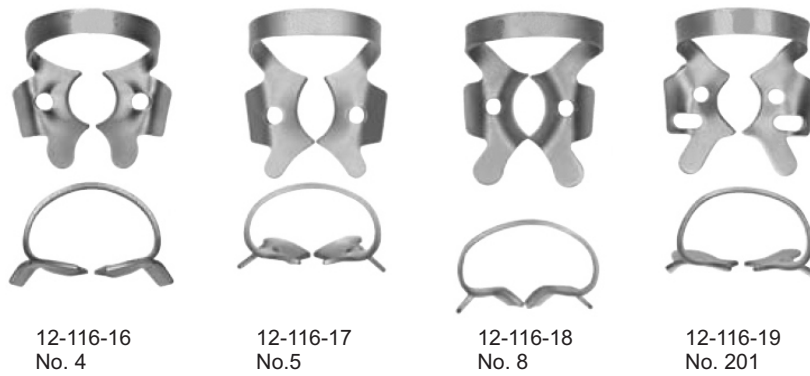



# HYGEIA SURGICO

## For lower molars



12-116-25  
No. 3



12-116-26  
No. 7



12-116-27  
No. 7A



12-116-28  
No. 26



12-116-29  
No. 12A



12-116-30  
No. 13A



12-116-31  
No. W3



12-116-32  
No. W7



12-116-33  
No. 28

## For upper & lower molars



12-116-34  
No. 8A



12-116-35  
No. 8AD



12-116-36  
No. 10



12-116-37  
No. 11



12-116-38  
No. 14



# HYGEIA SURGICO

*For upper & lower molars*

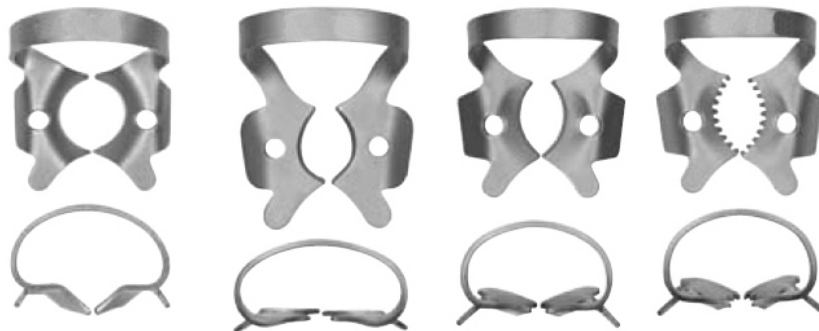

12-116-39  
No. 14A

12-116-40  
No. 27

12-116-41  
No. 56

12-116-42  
No. 56S



12-116-43  
No. W8A

12-116-44  
No. W14A

12-116-45  
No. 18

12-116-46  
No. 24

12-116-47  
No. 25

Clamp Forceps



12-117-01  
Ivory



12-117-02  
Brewer



12-117-03  
Stoke

Punch Forceps



12-117-04  
Ainsworth



12-117-05  
Ivory



Rubber Dam Frame  
12-117-06





# HYGEIA SURGICO



12-118-01  
Medium/Small  
20cm



12-118-02  
Medium/Large  
20cm



12-118-03  
Medium/Jumbo  
20cm



12-118-04  
Small, 1.5mmØ  
15.5cm



12-118-05  
Medium, 2mmØ  
15.5cm



12-118-06  
Large, 2.5mmØ  
15.5cm



12-118-07  
Jumbo, 3mmØ  
15.5cm



12-118-08  
Straight, 2mmØ  
15cm



12-118-09  
45° Bend, 2mmØ  
15cm



12-118-10  
90° Bend, 2mmØ  
15cm

Amalgam Well



12-118-11



12-118-12



12-118-13



# HYGEIA SURGICO



12-119-01

No. 00



12-119-02

No. 0



12-119-03

No. 1



12-119-04

No. 2



12-119-05

No. 3



12-119-06

No. 4



12-119-07

No. 1



12-119-08

No. 2



12-120-01  
Fig. 1



12-120-02  
Fig. 2



12-120-03  
Fig. 3



12-120-04  
Fig. 4



12-120-05  
Fig. 5



12-120-06  
Fig. 1  
Serrated



12-120-07  
Fig. 2  
Serrated



12-120-08  
Fig. 3  
Serrated



12-120-09  
Fig. 1L  
Smooth



12-120-10  
Fig. 2L  
Smooth



12-120-11  
Fig. 3L  
Smooth



# HYGEIA SURGICO



12-120-12  
Fig. 1  
Serrated



12-120-13  
Fig. 2  
Serrated



12-120-14  
Fig. 3  
Serrated



12-120-15  
Fig. 4  
Serrated



12-120-16  
Fig. 1L  
Smooth



12-120-17  
Fig. 2L  
Smooth



12-120-18  
Fig. 3L  
Smooth



12-120-19  
Fig. 4L  
Smooth



12-120-20  
Fig. 1



12-120-21  
Fig. 2



12-120-22  
Fig. 3



12-120-23  
Ward  
Fig. 1



12-120-24  
Ward  
Fig. 2



12-120-25  
Tanner  
Fig. 0



12-120-26  
Tanner  
Fig. 1



12-120-27  
Tanner  
Fig. 2



12-120-28  
Tanner  
Fig. 3



# HYGEIA SURGICO



12-120-29  
Marquette  
Fig. 01



12-120-30  
Hollenback  
Fig. H1



12-120-31  
Hollenback  
Fig. H2



12-120-32  
Hollenback  
Fig. H3



12-120-33  
Hollenback  
Fig. H4



12-120-34  
Markley  
Fig. 1



12-120-35  
Markley  
Fig. 2



12-120-36  
Markley  
Fig. 3



12-120-37  
Markley  
Fig. 4



12-120-38  
Markley  
Fig. 5



12-120-39  
Markley  
Fig. 6





# HYGEIA SURGICO



12-120-40  
Foc  
Fig. 0



12-120-41  
Foc  
Fig. 1



12-120-42  
Foc  
Fig. 2



12-120-43  
Foc  
Fig. 0S



12-120-44  
Foc  
Fig. 1S



12-120-45  
Foc  
Fig. 2S



IS-TiN / 12 - 120 - 46  
Goldstein Flexi Plastic Filling  
Fig. 3



12-121-01  
Fig. 1



12-121-02  
Fig. 2



12-121-03  
Fig. 1



12-121-04  
Fig. 2



12-121-05  
Fig. 1



12-121-06  
Fig. 2



12-121-07  
Fig. 3



12-121-08  
Fig. 1



12-121-09  
Fig. 2



12-121-10  
Fig. 3



12-121-11  
Fig. 1



12-121-12  
Fig. 2



12-121-13  
Fig. 3



12-121-14  
Woodson  
Fig. 1



12-121-15  
Woodson  
Fig. 2



12-121-16  
Woodson  
Fig. 3



12-121-17  
Fig. 11



12-121-18  
Fig. 6



12-121-19  
Fig. 179



# HYGEIA SURGICO



12-122-01  
Westcott  
Fig. 1



12-122-02  
Westcott  
Fig. 2



12-122-03  
Ladmore  
Fig. 2



12-122-04  
Ladmore  
Fig. 3



12-122-05  
Ball  
Fig. 18



12-122-06  
Ball  
Fig. 26-27S



12-122-07  
Ball  
Fig. 27-29



12-122-08  
Fig. A



12-122-09  
Fig. W3



12-122-10  
Fig. NYU/B2



12-122-011  
Fig. 2/31



# HYGEIA SURGICO



12-123-01  
Hollenback  
Fig. ½



12-123-02  
Hollenback  
Fig. 3



12-123-03  
Hollenback  
Fig. 3S



12-123-04  
Ward  
Fig. 1



12-123-05  
Ward  
Fig. 1S



12-123-06  
Ward  
Fig. 2



12-123-07  
Frahm  
Fig. 1



12-123-08  
USC  
Fig. 2



12-123-09  
Interproximal  
Fig. 1



12-123-10  
Interproximal  
Off-Angle  
Fig. 2



12-123-11  
Fig. SHO-A



12-123-12  
Fig. 3-SHO



12-123-13  
Fig. 104



12-123-14  
Wiland  
Fig. 8



12-123-15



12-123-16



12-123-17  
Cleoids - Discoids  
Fig. 1



12-123-18  
Cleoids - Discoids  
Fig. 2



12-123-19  
Cleoids - Discoids  
Fig. 3



12-123-20  
Cleoids - Discoids  
Fig. 4



**Gauze packers**



12-124-01  
Luniatschek  
2mm



12-124-02  
Luniatschek  
3mm

**Placement Instrument**



12-124-03



12-124-04  
Placement  
instrument

**Instrument for subgingival**



12-124-05  
Orban Loop



12-124-06





# HYGEIA SURGICO



12-125-01  
Black 26  
Fig. 1 Distal



12-125-02  
Black 27  
Fig. 2 Mesial



12-125-03  
Black 28  
Fig. 3 Distal



12-125-04  
Black 29  
Fig. 4 Mesial



12-125-05  
Black 77-78  
Fig. 1 Distal



12-125-06  
Black 79-80  
Fig. 2 Distal



12-125-07  
Black 53-54  
Fig. 1



12-125-08  
Black 51-52  
Fig. 2



12-125-09  
Wedelstaet  
Fig. 1/2



12-125-10  
Wedelstaet  
Fig. 3/4



12-125-11  
Wedelstaet  
Fig. 5/6



# HYGEIA SURGICO



12-126-01  
Fig. 0



12-126-02  
Fig. 1



12-126-03  
Fig. 2



12-126-04  
Fig. 3



12-126-05  
Fig. 4



12-126-06  
Fig. 1



12-126-07  
Fig. 2



12-126-08  
Fig. 6



12-126-09  
Fig. 14



# HYGEIA SURGICO



12-126-10  
Fig. 17



12-126-11  
Fig. 18



12-126-12  
Fig. 19



12-126-13  
Fig. 17W  
Oval Spoon



12-126-14  
Fig. 18W  
Oval Spoon



12-126-15  
Fig. 19W  
Oval Spoon



12-126-16  
Fig. 38/39



12-126-17  
Fig. 31L



12-126-18  
Fig. 32L



12-126-19  
Fig. 33L



12-126-20  
Fig. 5  
1 mm



12-126-21  
Fig. 14  
1.2 mm



12-126-22  
Fig. 17  
1 mm



12-126-23  
Fig. 18  
1.2 mm



12-126-24  
Fig. 19  
1.6 mm



12-126-25  
Fig. 20  
2.0 mm



12-126-26  
Darby - Perry  
Fig. 1  
0.8 mm



12-126-27  
Darby - Perry  
Fig. 2  
0.8 mm



12-126-28  
Darby - Perry  
Fig. 11  
1 mm



12-126-29  
Darby - Perry  
Fig. 12  
1 mm



12-126-30  
Darby - Perry  
Fig. 21  
1.2 mm



# HYGEIA SURGICO



12-126-31  
Darby - Perry  
Fig. 22  
1.2 mm

12-126-32  
Darby - Perry  
Fig. 31  
1.6 mm

12-126-33  
Darby - Perry  
Fig. 32  
1.6 mm

12-126-34  
Darby - Perry  
Fig. 41  
2 mm

12-126-35  
Darby - Perry  
Fig. 42  
2 mm

12-126-36  
ASH  
Fig. 243  
1 mm

2-126-37  
ASH  
Fig. G2  
1.4 mm



# HYGEIA SURGICO

## Crown Spreader



12-127-01  
No. 0



12-127-02  
No. 1



12-127-03  
No. 2



12-127-04  
No. 3



12-127-08  
Automatic

## Crown Remover



12-127-05



12-127-06



12-127-07



12-127-09  
Automatic



12-127-10

**Measuring Gauge**



12-127-11  
Boley  
14cm



12-127-12  
Iwanson

**Articular Paper Forceps**



12-127-13  
Miller  
15cm



12-127-14  
15cm

**Telescope Crown Plier**



12-127-15  
Bohm  
11.5cm



12-127-16  
Bohm  
14.5cm





# HYGEIA SURGICO



12-128-01  
Ivory 8  
5mm



12-128-02  
Ivory 8  
6mm



12-128-03  
Ivory 8  
7mm



12-128-04  
Ivory 8N



12-128-05  
Tofflemire  
Universal



12-128-06  
Tofflemire  
Senior



12-128-07  
Tofflemire  
Junior



# HYGEIA SURGICO



12-130-01  
Partsch  
Lead Filled  
19cm



12-130-02  
Mead  
With Plastic Insert  
19.5



# HYGEIA SURGICO



12-131-01  
Molt  
Fig. M7



12-131-02  
Molt  
Fig. M8



12-131-03  
Molt  
Fig. M9



12-131-04  
Goldmann - Fox  
Fig. GF



12-131-05  
Allen  
Fig. 9A



12-131-06  
Hourigan  
Fig. 2



12-131-07  
Hopkins  
Fig. 1



# HYGEIA SURGICO



12-131-08  
Hopkins  
Fig. 2

12-131-09  
Mead  
Fig. 3

12-131-10  
Pichard  
Fig. Pr3

12-131-11  
Freer  
Fig. 15

12-131-12  
Freer  
Fig. 16

12-131-13  
Parsch  
14.5cm

12-131-14  
Konig  
15.5cm



12-131-15  
Seldin  
Fig. 22



12-131-16  
Seldin  
Fig. 23



12-131-17  
Willinger  
17cm



12-131-18  
Willinger  
16cm



12-131-19  
Willinger  
16cm



12-131-20  
Willinger  
13cm



12-132-01  
Miller  
Fig. 45



12-132-02  
Miller  
Fig. 64



12-132-03  
Polokoff  
Fig. 1



12-132-04  
Fig. 10



12-132-05  
Fig. 33



12-132-06  
Fig. 12



12-132-07  
Fig. 12A



12-132-08  
Fig. 12CA





# HYGEIA SURGICO



12-133-01  
Hemingway  
Fig. 1



12-133-02  
Hemingway  
Fig. 2



12-133-03  
Hemingway  
Fig. 3



12-133-04  
Hemingway  
Fig. 4



12-133-05  
Lucas  
Fig. 85



12-133-06  
Lucas  
Fig. 86



12-133-07  
Lucas  
Fig. 87



12-133-08  
Lucas  
Fig. 88



12-134-01  
Sugarman  
Fig. 1S/2S



12-134-02  
Sugarman  
Fig. 3S/4S



12-134-03  
Schluger  
Fig. 9/10



12-134-04  
Hirschfeld  
Fig. 3/7



12-135-01  
TG Chisel  
Fig. 1



12-135-02  
TG Chisel  
Fig. 2



12-135-03  
TG Chisel  
Fig. 1/2



12-135-04  
Ochsenbein  
Fig. 3



12-135-05  
Ochsenbein  
Fig. 4



12-135-06  
Rhodes Back Action  
Fig. 36/37



12-135-07  
Zerfing



# HYGEIA SURGICO



12-136-01  
Kirkland (15K)  
Fig. 1



12-136-02  
Kirkland (16K)  
Fig. 2



12-136-03  
Kirkland (15/16K)  
Fig. 1/2



12-136-04  
Orban  
Fig. 1



12-136-05  
Orban  
Fig. 2



12-136-06  
Orban  
Fig. 1/2



12-136-07  
Goldman Fox  
Fig. 7



12-136-08  
Goldman Fox  
Fig. 8



12-136-09  
Goldman Fox  
Fig. 9



12-136-10  
Goldman Fox  
Fig. 11



12-136-11  
Buck  
Fig. 3/4



12-136-12  
Buck  
Fig. 5/6



12-136-13  
Sanders  
Fig. 1/2



12-136-14  
Sanders  
Fig. 4/5



12-136-15  
University of  
South California  
Fig. 19/20



12-136-16  
Crane - Kaplan  
Fig. CK3



# HYGEIA SURGICO



12-137-01  
Langer  
Fig. HU ½



12-137-02  
Langer  
Fig. 3/4



12-137-03  
Fig. HU ½



12-137-04  
Columbia  
Fig. 2R/2L



12-137-05  
Columbia  
Fig. 4R/4L



12-137-06  
Columbia  
Fig. 13/14



12-137-07  
Fig. 411/412



12-137-08  
Fig. 413/414



12-137-09  
De Marco  
Fig. 1



12-137-10  
De Marco  
Fig. 2



# HYGEIA SURGICO



12-137-11  
Goldman Fox  
Fig. 1



12-137-12  
Goldman Fox  
Fig. 2



12-137-13  
Goldman Fox  
Fig. 3



12-137-14  
Goldman Fox  
Fig. 4



12-137-15  
Goldman Fox  
Fig. 5



12-137-16  
Goldman Fox  
Fig. 6



12-137-17  
Goldman Fox  
Fig. 21



12-137-18  
Barnhart  
Fig. ½



12-137-19  
Barnhart  
Fig. 5/6



12-137-20  
10/11  
Fig. ME-1



12-137-21  
Rule (23/24)  
Fig. 3/4



# HYGEIA SURGICO



12-137-22  
Indiana University  
Fig. 13/14  
Anterior



12-137-23  
Indiana University  
Fig. 17/18  
Posterior



12-137-24  
Mc Calls  
Fig. 11/12

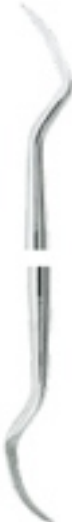

12-137-25  
Mc Calls  
Fig. 11A/12A



12-137-26  
Mc Calls  
Fig. 13/14



12-137-27  
Mc Calls  
Fig. 13S/14S



12-137-28  
Mc Calls  
Fig. 17S/18S



12-137-29  
Mc Calls  
Fig. 19/20



12-137-30  
Taylor  
Fig. 2/3



12-137-31  
Fig. 204



12-137-32  
Fig. 204S





# HYGEIA SURGICO



12-137-34  
Crane - Kaplan  
Fig. 6



12-137-35  
Crane - Kaplan  
Fig. 6S



12-137-36  
Younger - Good  
Fig. 7/8



12-137-37  
Jacquette  
Fig. 31/32



12-137-38  
Jacquette  
Fig. 30/33



12-137-39  
Jacquette  
Fig. 34/35



12-137-40  
Jacquette  
Fig. 37/38



# HYGEIA SURGICO

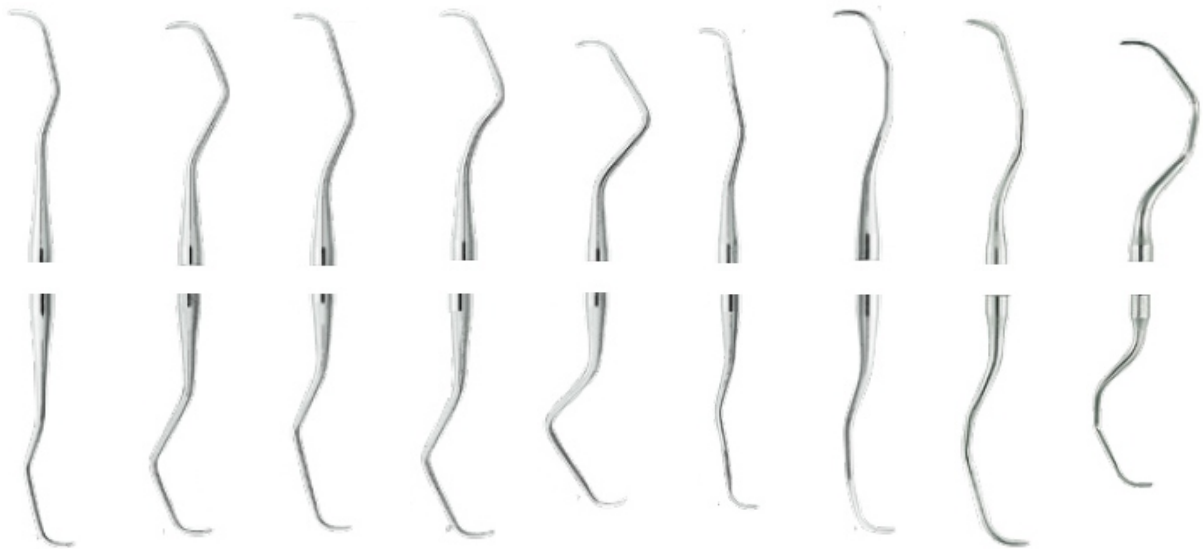

12-138-01	12-138-02	12-138-03	12-138-04	12-138-05	12-138-06	12-138-07	12-138-08	12-138-09
No. ½	No. 3/4	No. 5/6	No. 7/8	No. 9/10	No. 11/12	No. 13/14	No. 15/16	No. 17/18



# HYGEIA SURGICO



12-139-01  
Towner Jaquette  
Fig. U15/33



12-139-02  
Towner Jaquette  
Fig. U15/30



12-139-03  
Fig. H5/33



12-139-04  
Fig. H6/H7



12-139-05  
Fig. 1/2



12-139-06  
Towner  
Fig. U15



12-139-07  
Fig. 1



12-139-08  
Fig. 1L  
For left



12-139-09  
Fig. 1R  
For Right



12-139-10  
Fig. 2L  
For Left



12-139-11  
Fig. 2R  
For Right



12-139-12  
Fig. 33



12-139-13  
Hygienist  
Fig. H5



12-139-14  
Hygienist  
Fig. H6



12-139-15  
Hygienist  
Fig. H7

## Stainless Steel

SOLID

Set of 10 Pieces  
12-140-10S



12-140-01  
U1



12-140-02  
U2



12-140-03  
U3



12-140-04  
U4



12-140-05  
U5



12-140-06  
L1



12-140-07  
L2



12-140-08  
L3



12-140-09  
L4



12-140-10  
L5

All the above impression trays are available in these 5 sizes

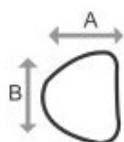

UPPER		U1	U2	U3	U4	U5
	A	62	60	53	54	52
B	85	75	73	69	68	

All Dimension are in mm

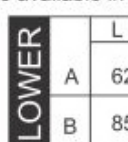

LOWER		L1	L2	L3	L4	L5
	A	62	60	53	54	52
B	85	75	73	69	68	

All Dimension are in mm

PERFORATED

Set of 10 Pieces  
12-140-20S



12-140-11  
U1



12-140-12  
U2

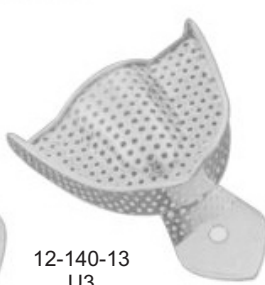

12-140-13  
U3



12-140-14  
U4

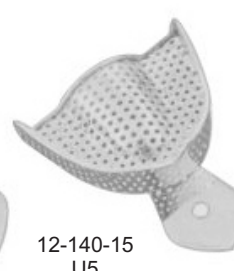

12-140-15  
U5



12-140-16  
L1



12-140-17  
L2



12-140-18  
L3



12-140-19  
L4



12-140-20  
L5



# HYGEIA SURGICO

Stainless Steel

SOLID FULL DENTURE SET

Set of 08 Pieces  
12-140-28S



12-140-21  
XL



12-140-22  
L



12-140-23  
M



12-140-24  
S



12-140-25  
XL



12-140-26  
L



12-140-27  
M



12-140-28  
S

All the above impression trays are available in these 4 sizes

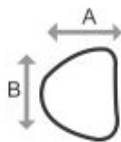

UPPER		XL	L	M	S
	A	70	67	64	60
B	79	76	70	73	

All Dimension are in mm

LOWER		XL	L	M	S
	A	64	64	60	57
B	86	70	73	70	

All Dimension are in mm

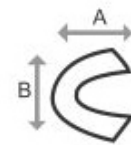

PERFORATED FULL DENTURE SET

Set of 08 Pieces  
12-140-36S



12-140-29  
XL



12-140-30  
L



12-140-31  
M



12-140-32  
S



12-140-33  
XL



12-140-34  
L



12-140-35  
M



12-140-36  
S

Stainless Steel

SOLID

Set of 06 Pieces  
12-140-42S



12-140-37  
U1



12-140-38  
U2



12-140-39  
U3



12-140-40  
L1



12-140-41  
L2



12-140-42  
L3

All the above impression trays are available in these 3 sizes

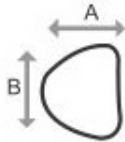

UPPER	U 1	U 2	U 3
	A	67	64
B	81	71	70

All Dimension are in mm

LOWER	L 1	L 2	L 3
	A	60	57
B	81	79	76

All Dimension are in mm

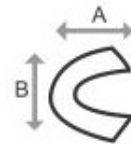

PERFORATED

Set of 06 Pieces  
12-140-48S



12-140-43  
U1



12-140-44  
U2



12-140-45  
U3



12-140-46  
L1



12-140-47  
L2



12-140-48  
L3



Stainless Steel

PERFORATED

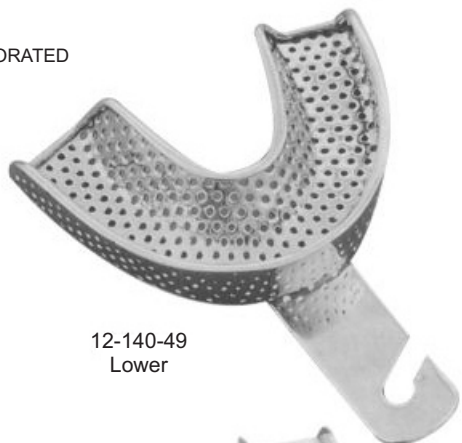

12-140-49  
Lower

English Pattern

Set of 08 Pieces  
12-140-56S



12-140-50  
Upper

PUNCHED

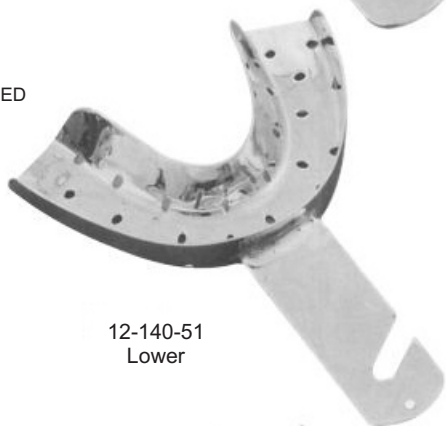

12-140-51  
Lower

Set of 08 Pieces  
12-140-64S

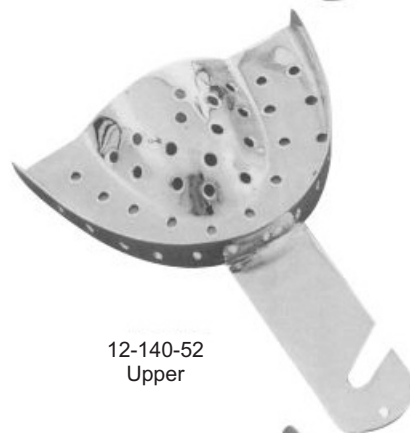

12-140-52  
Upper

SOLID



12-140-53  
Lower

Set of 08 Pieces  
12-140-72S



12-140-54  
Upper

All the above impression trays are available in these 3 sizes

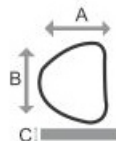

UPPER	Size	A	B	C
	0	67	50	12
	1	72	51	13
	2	78	55	15
	3	80	58	15

All Dimension are in mm

LOWER	Size	A	B	C
	0	70	50	14
	1	77	51	15
	2	79	55	15
	3	80	60	17

All Dimension are in mm

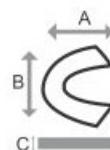



# HYGEIA SURGICO

Stainless Steel

SOLID FULL DENTURE SET

Set of 08 Pieces  
12-140-80S

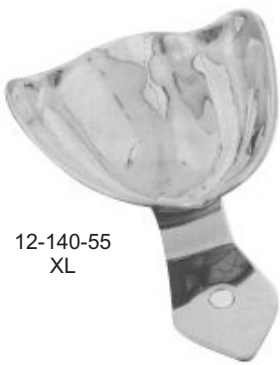

12-140-55  
XL

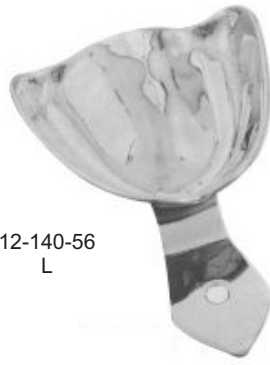

12-140-56  
L



12-140-57  
M



12-140-58  
S



12-140-59  
XL



12-140-60  
L



12-140-61  
M



12-140-62  
S

All the above impression trays are available in these 3 sizes

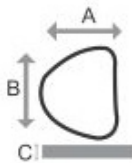

UPPER		XL	L	M	S
	A	70	67	64	60
B	79	76	70	73	

All Dimension are in mm

LOWER		XL	L	M	S
	A	64	64	60	57
B	86	70	73	70	

All Dimension are in mm

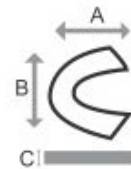

12-140-63  
XL



12-140-64  
L



12-140-65  
M

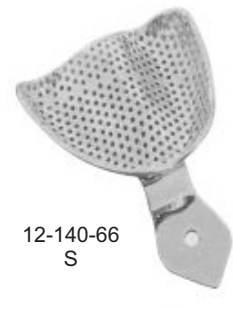

12-140-66  
S

Set of 08 Pieces  
12-140-88S



12-140-67  
XL

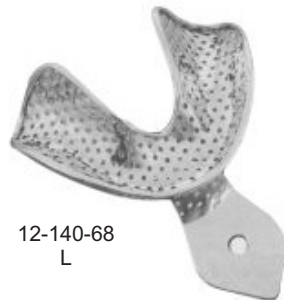

12-140-68  
L



12-140-69  
M

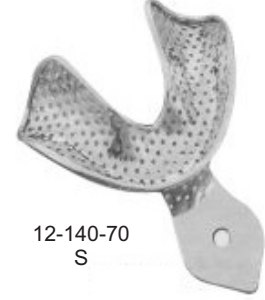

12-140-70  
S

PERFORATED FULL DENTURE SET



# db HYGEIA SURGICO

Stainless Steel

SOLID FULL DENTURE SET

Set of 08 Pieces  
12-140-96S



12-140-71  
XL



12-140-72  
L



12-140-73  
M



12-140-74  
S



12-140-75  
XL



12-140-76  
L



12-140-77  
M



12-140-78  
S

Upper sizes 0,1,2,3,  
Depth of the tray 15,9 mm  
Height of palate 12,5 mm

Lower sizes 0,1,2,3,  
Depth of the tray 12,9 mm

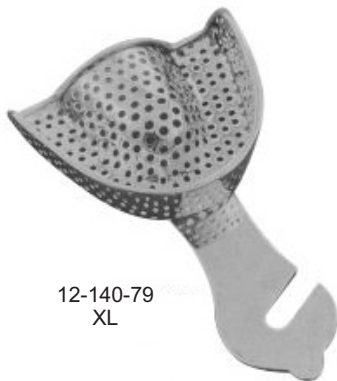

12-140-79  
XL

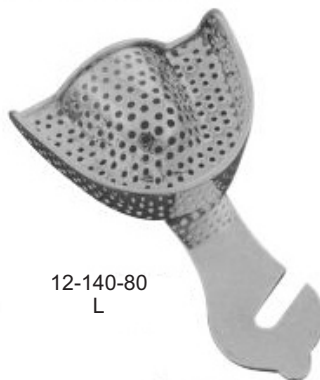

12-140-80  
L

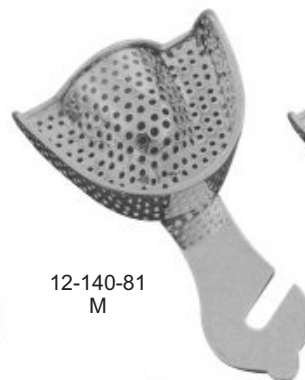

12-140-81  
M

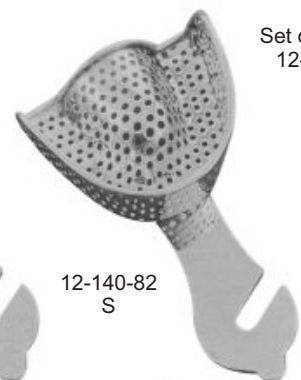

12-140-82  
S

Set of 08 Pieces  
12-140-104S



12-140-83  
XL



12-140-84  
L



12-140-85  
M



12-140-86  
S

PERFORATED FULL DENTURE SET

Stainless Steel

IMPRESSION TRAYS FOR CROWN AND BRIDGE WORK

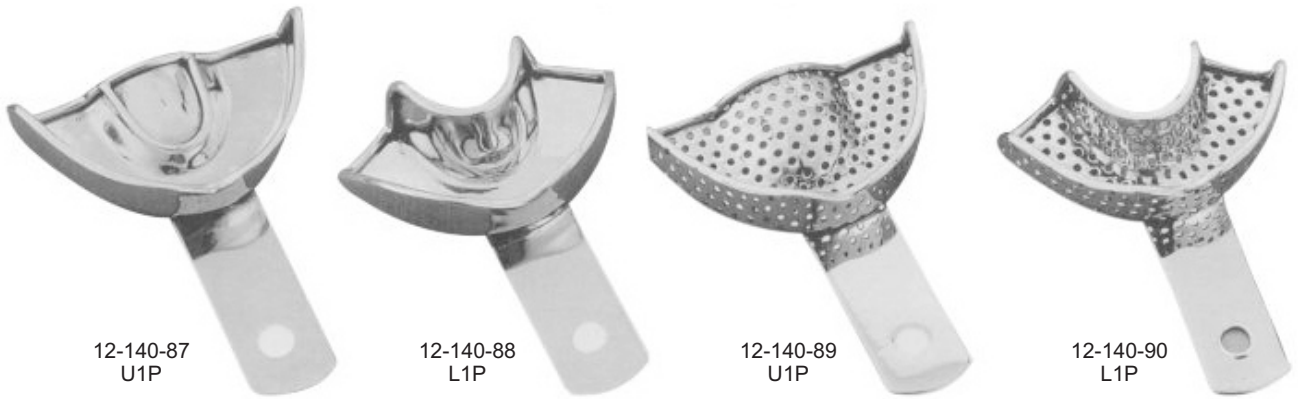

12-140-87  
U1P

12-140-88  
L1P

12-140-89  
U1P

12-140-90  
L1P

Solid

Perforated



Perforated

12-140-91  
For Upper Right Jaw  
For Lower Left Jaw

12-140-92  
For Upper Left Jaw  
For Lower Right Jaw

12-140-93  
Adjustable  
Perforated

12-140-94  
Solid

Available In following sizes  
44 mm  
55 mm  
60 mm  
65 mm

Also Available In Solid Pattern



# HYGEIA SURGICO



12-142-01  
Zahle

12-142-02  
Zahle

12-142-03  
Zahle

12-142-04  
Hylin

12-142-05  
Hylin Lecron

12-142-06  
Hylin - Ceramica

12-142-07  
Hylin Sacred

12-142-08  
Sacred



# HYGEIA SURGICO



12-142-09  
Le Cron



12-142-10  
Le Cron



12-142-11  
Le Cron



12-142-12  
Le Cron



12-142-13  
Vehe



12-142-14  
Beale



12-142-15  
Roach



12-142-16  
Gritman



12-142-17  
P.K Thomas  
Fig. 1



12-142-18  
P.K Thomas  
Fig. 2



12-142-19  
P.K Thomas  
Fig. 3



12-142-20  
P.K Thomas  
Fig. 4



12-142-21  
P.K Thomas  
Fig. 5



# HYGEIA SURGICO



12-143-01  
Straight, Serrated  
16.5cm



12-143-02  
Curved, Serrated  
16cm



12-143-03  
Serrated  
15cm



12-143-04  
Serrated  
18cm



12-143-05  
Serrated  
26cm



12-143-06  
Delicate Points  
11.5cm



12-143-07  
Delicate Points  
12cm





# HYGEIA SURGICO



12-144-01  
Fahnenstock  
12.5



12-144-02  
Lessmann  
12.5



12-144-03  
Con Scodellino  
12.5



12-144-04  
Fahnenstock  
17cm



12-144-05  
Lessmann  
17cm



12-144-06  
Con Scodellino  
17cm



12-144-07  
17cm



12-144-08  
Gritman  
17cm



12-144-09  
16cm



12-144-10  
16cm





# HYGEIA SURGICO



12-145-01

Flexible  
19.5cm



12-145-02

Flexible  
21.0cm



12-145-03

Flexible  
20.5cm



12-145-04

Flexible  
19.5cm



12-145-05

Rigid  
20.0cm



12-145-06

Rigid  
22.0cm



# HYGEIA SURGICO



12-146-01

31cm

12-146-02

40cm

12-146-03

51cm



# HYGEIA SURGICO



12-147-01  
For 20 instruments  
288x182x34mm



12-147-02  
For 15 instruments  
288x182x34mm



12-147-03  
For 10 instruments  
288x182x34mm



12-147-04  
For 10 instruments  
182x144x34mm



12-147-05  
For 5 instruments  
182x144x34mm

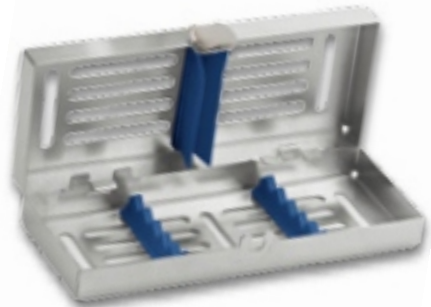

12-147-06  
For 5 instruments  
182x72x34mm